

ENTRANCES

August 2010

REBCO'S IN FRONT!!!



REBCO

1171 - 1225 Madison Avenue, P.O. Box 2248, Paterson, NJ 07509 - 2248 **INCORPORATED**

NJ 973 - 684 - 0200 • NY 212 - 736 - 6435
Outside NY/NJ 800 - 777 - 0787 • FAX 973 - 684 - 0118

e-mail: sales@REBCOinc.com • www.REBCOinc.com

TERMS & CONDITIONS OF SALE FOR REBCO STOCK LENGTHS, WINDOWS AND ENTRANCES

Unless otherwise agreed in writing, all proposals, quotations and sales are made upon the following terms and conditions. No modifications, changes, additions, deletions or suspensions will be binding upon REBCO. Any orders accepted by REBCO are conditioned upon the following terms and conditions of sale:

ORDER ACCEPTANCE AND DELIVERY

1. When accepted by REBCO, orders become binding contracts and any changes and/or cancellations are subject to charges for costs incurred.
2. In cases of strikes, fires, floods, snows, accidents, common carrier delays, failure of outside vendors to deliver materials or parts, and other problems beyond our control, REBCO assumes no responsibility nor economic liability for failure to meet planned delivery schedule. Every effort will be made to return to schedule as soon as possible following the event.
3. Delivery dates indicated in confirmation of order are approximate only and shall not subject the Company to any economic liability for failure to meet the approximate shipping schedule.
4. Title to materials sold shall pass to the buyer on delivery to common carrier at point of shipment, however, the seller shall retain a lien for payment on the materials so sold until the purchase price has been paid in full.
5. Back orders for material omitted from the original shipment because of shortage of stock or other conditions beyond our control, shall be on the same terms and conditions of sale as if it were included in the original shipment.

PRICES AND QUOTATIONS

1. Prices are subject to change without notice. In the event of a price change, orders on hand shall be invoiced at the prices in effect at the time orders are shipped.
2. Prices quoted herein are List Prices, unless otherwise specified, and are subject to discount prevailing at the time orders were received.
3. Prices are F.O.B. point of manufacture. No allowances shall be made for transportation charges.
4. Quotations unless otherwise noted are subject to placement of orders within 30 days. Changes in prices that have been made for materials included in quotations shall become effective at the end of the 30 day period.
5. REBCO Inc. will not be responsible for any losses sustained by purchasers through the use of an obsolete price list or pages thereof.
6. Taxes or other government charges upon the manufacture, sale or shipment of materials listed herein as imposed by Federal, State or Municipal authority shall be added to the price to be paid by the purchaser.

PAYMENT

1. Other than for cash or C.O.D. accounts, terms of sale are net 30 days.
2. Past due accounts shall be subject to an interest charge of 1-1/5% per month on the unpaid balance.
3. Back charges for repairs or alterations will not be allowed unless specifically accepted in advance in writing by REBCO, Inc. We shall not assume backcharges for labor or materials required on the job site due to inaccuracies caused by the use of templates for cut-outs or dealer approved drawings and dimensions.
4. Cancellations of custom work will not be accepted without charges for labor, materials and related expenses.

CLAIMS

1. Purchaser shall immediately check all materials on receipt and any damages, defects, shortages or improper character shall be reported to REBCO Inc. in writing within five days of receipt of said material. Failure to so notify shall constitute waiver of any claim against REBCO Inc. for such conditions.
2. In no event shall REBCO Inc. be responsible for any damage arising from the use of damaged, defective or improper character of materials.

3. Any material deemed defective which is covered under our warranty shall be repaired or replaced under the terms of a warranty. Labor or other expenditure incurred by the purchaser or any other party in consequence of such a material defect cannot be claimed.

RETURNED MATERIAL

1. Returned material shall not be accepted unless previously authorized, and documented on a Return Goods Report ticket. The returned material must be accompanied by the Return Goods Report. Material must be returned within 30 days from receipt of ticket.
2. Credits will not be allowed for unclean and improperly wrapped material or material which has been cut or damaged.
3. Returned material shall be subject to Company inspection. Credit for saleable material shall be allowed at the invoiced price less a 15% minimum handling charge.
4. Transportation costs on returned material shall be prepaid by the buyer.

GENERAL

1. Unless otherwise specified, entrances will be provided with M.S. lock, 2 cylinders, standard push/pull, flush bolts on inactive doors, glazing pocket for 1/4" glass, and 1-3/4" x 4-1/2" framing.
2. In an effort to maintain the most current styles and latest design innovations, we may find it necessary to change details without notice.
3. Special hardware may require modifications to our standard products which can change the look of a product, be it windows, doors or entrances. If a particular style is to be maintained please notify us.
4. Hardware furnished by others must be in the plant before an order is placed into fabrication. A delay in the timely receipt of purchaser supplied hardware will delay accordingly, shipment of an order. Expediting hardware will be the responsibility of the purchaser. Any expense incurred to modify and/or to repair hardware which is inaccurate or defective will be charged to the buyer. Any defects or inaccuracies related to hardware by others will be resolved by the purchaser and the hardware supplier. It is the responsibility of the purchaser to ascertain whether or not the custom hardware to be provided can be used with the entrances being ordered.
5. Ordering the materials, hardware and entrances acceptable by local building and fire codes is the responsibility of the purchaser.
6. REBCO, Inc. is not responsible for typographic errors or errors of omission in this catalog.

PURCHASER'S RESPONSIBILITIES

1. The purchaser accepts responsibility for ordering material which will conform to all of the local, state and federal building codes as well as to A.D.A. standards.
2. All materials shall be installed by experienced mechanics and shall conform to the highest standards of the industry, i.e. all materials shall be set in their proper locations, plumb, level, square, clean and be provided a solid anchoring surface.
3. Fasteners, where exposed, shall be aluminum, stainless steel or plated steel in accordance with ASTM A164. Perimeter anchors shall be aluminum or steel providing the steel is properly isolated from the aluminum. Where aluminum sections are placed in contact with steel, concrete, plaster, or other dissimilar materials, the entire aluminum surface of contact shall be back painted with a heavy coat of approved bituminous paint.
4. All joints between the aluminum framing and the wood or masonry shall be sealed in order to secure a watertight installation. *NOTE: REBCO, Inc. does not normally provide structural support of the framing system, trim, and/or metal sub sills. REBCO may at its option and if requested to do so, provide one or more of these options if they are specified by the purchaser.*
5. The purchaser shall protect the aluminum entrance, window and/or frame material and finish against damage from construction activities and harmful substances. Upon completion of construction, the purchaser and/or general contractor shall be responsible for cleaning the aluminum with plain water containing mild soap or detergent or a petroleum product such as white gasoline, kerosene, or distillate. No abrasive agent shall be used.

STANDARD UNIT SPECIFICATIONS:

- Narrow N.S. Door with 1³/₄" x 4¹/₂" framing.
- N.S. Door comes complete with M.S. Lock, cylinders both sides, or flush bolts on the inactive leaf of a pair and standard push/pull hardware.
- Standard doors are prepped for 1/4" glazing.
1" glazing prep on doors is available upon request only.
- Frames are complete with door stops, glazing pockets in transom area, and exterior pockets in jamb.
- 5" Aluminum Threshold is standard.
- Pair of butts or top & bottom pivots.
- No glass or closers included. (See p. 20 for closer).

ENTRANCES

Butt Hung (B) or Offset Pivots (P)

The best narrow stile door on the market!

REBCO's main door members have a wall thickness of .125" and stop thickness of .050". Joints are mechanically fastened and then 100% deep penetration welded on unexposed surfaces. Standard doors are complete with Adams Rite deadlock cylinders on both sides, or flush bolts in the inactive leaf of pair of doors, and our standard push & pulls.

| Type | Part Number | Nominal Door Size | Non-thermal Framing | Frame Size | Glazing Pocket for | (-1) Clear | (-2) Dk. Bronze | (-4) White | (-5) Black |
|--------------|--------------------------------------|----------------------------|---|--|--------------------|------------|-----------------|------------|------------|
| BUTT HUNG | B-ED-1- B-ED-2- | 3'0" x 7'0" 3'6" x 7'0" | 1 ³ / ₄ " x 4 ¹ / ₂ " | 39 ¹ / ₂ " x 85 ³ / ₄ " 45 ¹ / ₂ " x 85 ³ / ₄ " | 1/4" | | | | |
| | 1 B-ED-1- 1 B-ED-2- | 3'0" x 7'0" 3'6" x 7'0" | 2" x 4 ¹ / ₂ " | 40" x 86" 46" x 86" | 1" | | | | |
| OFFSET PIVOT | P-ED-1- P-ED-2- | 3'0" x 7'0" 3'6" x 7'0" | 1 ³ / ₄ " x 4 ¹ / ₂ " | 39 ¹ / ₂ " x 85 ³ / ₄ " 45 ¹ / ₂ " x 85 ³ / ₄ " | 1/4" | | | | |
| | 1 P-ED-1- 1 P-ED-2- | 3'0" x 7'0" 3'6" x 7'0" | 2" x 4 ¹ / ₂ " | 40" x 86" 46" x 86" | 1" | | | | |

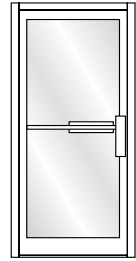

| Type | Part Number | Nominal Door Size | Non-thermal Framing | Frame Size | Glazing Pocket for | (-1) Clear | (-2) Dk. Bronze | (-4) White | (-5) Black |
|--------------|--|----------------------------|---|--|--------------------|------------|-----------------|------------|------------|
| BUTT HUNG | B-EDD-1- B-EDD-2- | 6'0" x 7'0" 7'0" x 7'0" | 1 ³ / ₄ " x 4 ¹ / ₂ " | 75 ¹ / ₂ " x 85 ³ / ₄ " 87 ¹ / ₂ " x 85 ³ / ₄ " | 1/4" | | | | |
| | 1 B-EDD-1- 1 B-EDD-2- | 6'0" x 7'0" 7'0" x 7'0" | 2" x 4 ¹ / ₂ " | 76" x 86" 88" x 86" | 1" | | | | |
| OFFSET PIVOT | P-EDD-1- P-EDD-2- | 6'0" x 7'0" 7'0" x 7'0" | 1 ³ / ₄ " x 4 ¹ / ₂ " | 75 ¹ / ₂ " x 85 ³ / ₄ " 87 ¹ / ₂ " x 85 ³ / ₄ " | 1/4" | | | | |
| | 1 P-EDD-1- 1 P-EDD-2- | 6'0" x 7'0" 7'0" x 7'0" | 2" x 4 ¹ / ₂ " | 76" x 86" 88" x 86" | 1" | | | | |

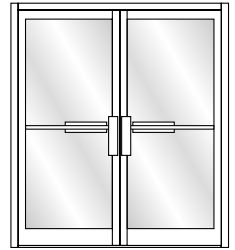

| Type | Part Number | Nominal Door Size | Non-thermal Framing | Frame Size | Glazing Pocket for | (-1) Clear | (-2) Dk. Bronze | (-4) White | (-5) Black |
|--------------|--|----------------------------|---|--|--------------------|------------|-----------------|------------|------------|
| BUTT HUNG | B-ETD-1- B-ETD-2- | 3'0" x 7'0" 3'6" x 7'0" | 1 ³ / ₄ " x 4 ¹ / ₂ " | 39 ¹ / ₂ " x 120" 45 ¹ / ₂ " x 120" | 1/4" | | | | |
| | 1 B-ETD-1- 1 B-ETD-2- | 3'0" x 7'0" 3'6" x 7'0" | 2" x 4 ¹ / ₂ " | 40" x 120" 46" x 120" | 1" | | | | |
| OFFSET PIVOT | P-ETD-1- P-ETD-2- | 3'0" x 7'0" 3'6" x 7'0" | 1 ³ / ₄ " x 4 ¹ / ₂ " | 39 ¹ / ₂ " x 120" 45 ¹ / ₂ " x 120" | 1/4" | | | | |
| | 1 P-ETD-1- 1 P-ETD-2- | 3'0" x 7'0" 3'6" x 7'0" | 2" x 4 ¹ / ₂ " | 40" x 120" 46" x 120" | 1" | | | | |

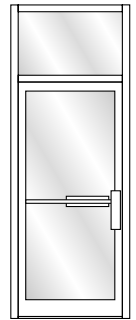

| Type | Part Number | Nominal Door Size | Non-thermal Framing | Frame Size | Glazing Pocket for | (-1) Clear | (-2) Dk. Bronze | (-4) White | (-5) Black |
|--------------|--|----------------------------|---|--|--------------------|------------|-----------------|------------|------------|
| BUTT HUNG | B-ETDD-1- B-ETDD-2- | 6'0" x 7'0" 7'0" x 7'0" | 1 ³ / ₄ " x 4 ¹ / ₂ " | 75 ¹ / ₂ " x 120" 87 ¹ / ₂ " x 120" | 1/4" | | | | |
| | 1 B-ETDD-1- 1 B-ETDD-2- | 6'0" x 7'0" 7'0" x 7'0" | 2" x 4 ¹ / ₂ " | 76" x 120" 88" x 120" | 1" | | | | |
| OFFSET PIVOT | P-ETDD-1- P-ETDD-2- | 6'0" x 7'0" 7'0" x 7'0" | 1 ³ / ₄ " x 4 ¹ / ₂ " | 75 ¹ / ₂ " x 120" 75 ¹ / ₂ " x 120" | 1/4" | | | | |
| | 1 P-ETDD-1- 1 P-ETDD-2- | 6'0" x 7'0" 7'0" x 7'0" | 2" x 4 ¹ / ₂ " | 76" x 120" 88" x 120" | 1" | | | | |

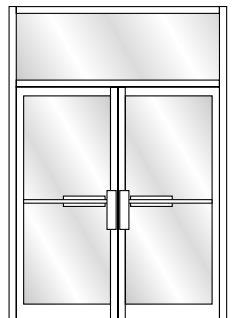

ENTRANCES

Center Hung (CH) Doors Double Acting

The best narrow stile door on the market!

REBCO's main members have a wall thickness of .125" and stop thickness of .050". Joints are mechanically fastened and then 100% deep penetration welded on unexposed surfaces.

STANDARD UNITS SHIP WITH:

- Narrow Stile Doors and 1³/₄" x 4¹/₂" Frame.
- Standard Push on both sides of door. (Push/Pull, or Pull/Pull will be provided instead, if requested.)
- Doors complete with MS lock, cylinders on both sides or flush bolts on the inactive leaf of a pair.
- Narrow stile doors prepped for 1/4" glass.
- 5" aluminum threshold.
- Top CH Pivot (Walking Beam) & Bottom Pivot (door and floor portion).
- No closer or glass included.

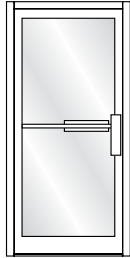

| Type | Part Number | Nominal Door Size | Non-thermal Framing | Frame Size | Glazing Pocket for | (-1) Clear | (-2) Dk. Bronze | (-4) White | (-5) Black |
|------------------------|-------------------|-------------------|---|---|--------------------|------------|-----------------|------------|------------|
| CENTER HUNG PIVOT DOOR | CH-ED-1- | 3'0" x 7'0" | 1 ³ / ₄ " x 4 ¹ / ₂ " | 39 ¹ / ₂ " x 85 ³ / ₄ " | 1/4" | | | | |
| | CH-ED-2- | 3'6" x 7'0" | | 45 ¹ / ₂ " x 85 ³ / ₄ " | | | | | |
| | 1 CH-ED-1- | 3'0" x 7'0" | 2" x 4 ¹ / ₂ " | 40" x 86" | 1" | | | | |
| | 1 CH-ED-2- | 3'6" x 7'0" | | 46" x 86" | | | | | |

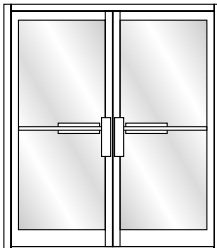

| Type | Part Number | Nominal Door Size | Non-thermal Framing | Frame Size | Glazing Pocket for | (-1) Clear | (-2) Dk. Bronze | (-4) White | (-5) Black |
|------------------------|--------------------|-------------------|---|---|--------------------|------------|-----------------|------------|------------|
| CENTER HUNG PIVOT DOOR | CH-EDD-1- | 6'0" x 7'0" | 1 ³ / ₄ " x 4 ¹ / ₂ " | 75 ¹ / ₂ " x 85 ³ / ₄ " | 1/4" | | | | |
| | CH-EDD-2- | 7'0" x 7'0" | | 87 ¹ / ₂ " x 85 ³ / ₄ " | | | | | |
| | 1 CH-EDD-1- | 6'0" x 7'0" | 2" x 4 ¹ / ₂ " | 76" x 86" | 1" | | | | |
| | 1 CH-EDD-2- | 7'0" x 7'0" | | 88" x 86" | | | | | |

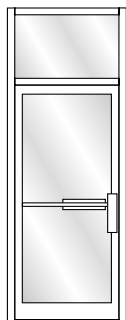

| Type | Part Number | Nominal Door Size | Non-thermal Framing | Frame Size | Glazing Pocket for | (-1) Clear | (-2) Dk. Bronze | (-4) White | (-5) Black |
|------------------------|--------------------|-------------------|---|---|--------------------|------------|-----------------|------------|------------|
| CENTER HUNG PIVOT DOOR | CH-ETD-1- | 3'0" x 7'0" | 1 ³ / ₄ " x 4 ¹ / ₂ " | 39 ¹ / ₂ " x 120" | 1/4" | | | | |
| | CH-ETD-2- | 3'6" x 7'0" | | 45 ¹ / ₂ " x 120" | | | | | |
| | 1 CH-ETD-1- | 3'0" x 7'0" | 2" x 4 ¹ / ₂ " | 40" x 120" | 1" | | | | |
| | 1 CH-ETD-2- | 3'6" x 7'0" | | 46" x 120" | | | | | |

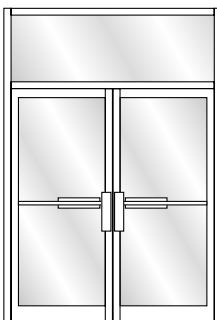

| Type | Part Number | Nominal Door Size | Non-thermal Framing | Frame Size | Glazing Pocket for | (-1) Clear | (-2) Dk. Bronze | (-4) White | (-5) Black |
|------------------------|---------------------|-------------------|---|---|--------------------|------------|-----------------|------------|------------|
| CENTER HUNG PIVOT DOOR | CH-ETDD-1- | 6'0" x 7'0" | 1 ³ / ₄ " x 4 ¹ / ₂ " | 75 ¹ / ₂ " x 120" | 1/4" | | | | |
| | CH-ETDD-2- | 7'0" x 7'0" | | 87 ¹ / ₂ " x 120" | | | | | |
| | 1 CH-ETDD-1- | 6'0" x 7'0" | 2" x 4 ¹ / ₂ " | 76" x 120" | 1" | | | | |
| | 1 CH-ETDD-2- | 7'0" x 7'0" | | 88" x 120" | | | | | |

OPTIONAL , UPON REQUEST:

- Closers - 105° H.O., 90° H.O., 90° no H.O.

COC: Units will contain doors with end-load arms and C.H. floor pivots. Frames are fabricated to receive doors and will contain concealed closers. Sash will be provided as required, in frames with transoms. **Specify Push/Pull, Push/Push or Pull/Pull.**

CXC: Units will contain doors with offset arms, slide channels and butts or offset pivots. Frames are fabricated to receive doors and will contain concealed closers, offset arm cover and door stops. Sash will be provided as required in the transom area. **Standard Push/Pull.**

CONCEALED Center Hung (COC) or Offset (CXC)

STANDARD UNIT SHIPS WITH:

- Narrow Stile Doors and 1 3/4" x 4 1/2" Frame.
- Narrow Stile Door complete with M.S. lock, cylinders both sides, or flush bolts in the inactive leaf of a pair with push and/or pull hardware.
- Doors prepped for 1/4" glass.
- 5" Aluminum Threshold.
- 105° No H.O. Concealed Overhead Closer with Arm.

| Type | Part Number | Nominal Door Size | Non-thermal Framing | Frame Size | Glazing Pocket for | (-1) Clear | (-2) Dk. Bronze | (-4) White | (-5) Black |
|-------------|--|----------------------------|---------------------|--|--------------------|------------|-----------------|------------|------------|
| CENTER HUNG | COC-ED-1- COC-ED-2- | 3'0" x 7'0" 3'6" x 7'0" | 1 3/4" x 4 1/2" | 39 1/2" x 85 3/4" 45 1/2" x 85 3/4" | 1/4" | | | | |
| | 1 COC-ED-1- 1 COC-ED-2- | 3'0" x 7'0" 3'6" x 7'0" | 2" x 4 1/2" | 40" x 86" 46" x 86" | 1" | | | | |
| OFFSET | CXC-ED-1- CXC-ED-2- | 3'0" x 7'0" 3'6" x 7'0" | 1 3/4" x 4 1/2" | 39 1/2" x 85 3/4" 45 1/2" x 85 3/4" | 1/4" | | | | |
| | 1 CXC-ED-1- 1 CXC-ED-2- | 3'0" x 7'0" 3'6" x 7'0" | 2" x 4 1/2" | 40" x 86" 46" x 86" | 1" | | | | |

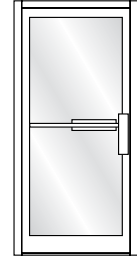

| Type | Part Number | Nominal Door Size | Non-thermal Framing | Frame Size | Glazing Pocket for | (-1) Clear | (-2) Dk. Bronze | (-4) White | (-5) Black |
|-------------|--|----------------------------|---------------------|--|--------------------|------------|-----------------|------------|------------|
| CENTER HUNG | COC-EDD-1- COC-EDD-2- | 6'0" x 7'0" 7'0" x 7'0" | 1 3/4" x 4 1/2" | 75 1/2" x 85 3/4" 87 1/2" x 85 3/4" | 1/4" | | | | |
| | 1 COC-EDD-1- 1 COC-EDD-2- | 6'0" x 7'0" 7'0" x 7'0" | 2" x 4 1/2" | 76" x 86" 88" x 86" | 1" | | | | |
| OFFSET | CXC-EDD-1- CXC-EDD-2- | 6'0" x 7'0" 7'0" x 7'0" | 1 3/4" x 4 1/2" | 75 1/2" x 85 3/4" 87 1/2" x 85 3/4" | 1/4" | | | | |
| | 1 CXC-EDD-1- 1 CXC-EDD-2- | 6'0" x 7'0" 7'0" x 7'0" | 2" x 4 1/2" | 76" x 86" 88" x 86" | 1" | | | | |

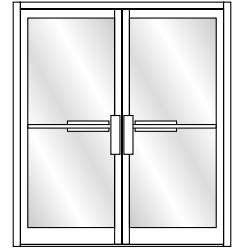

| Type | Part Number | Nominal Door Size | Non-thermal Framing | Frame Size | Glazing Pocket for | (-1) Clear | (-2) Dk. Bronze | (-4) White | (-5) Black |
|-------------|--|----------------------------|---------------------|----------------------------------|--------------------|------------|-----------------|------------|------------|
| CENTER HUNG | COC-ETD-1- COC-ETD-2- | 3'0" x 7'0" 3'6" x 7'0" | 1 3/4" x 4 1/2" | 39 1/2" x 120" 45 1/2" x 120" | 1/4" | | | | |
| | 1 COC-ETD-1- 1 COC-ETD-2- | 3'0" x 7'0" 3'6" x 7'0" | 2" x 4 1/2" | 40" x 120" 46" x 120" | 1" | | | | |
| OFFSET | CXC-ETD-1- CXC-ETD-2- | 3'0" x 7'0" 3'6" x 7'0" | 1 3/4" x 4 1/2" | 39 1/2" x 120" 45 1/2" x 120" | 1/4" | | | | |
| | 1 CXC-ETD-1- 1 CXC-ETD-2- | 3'0" x 7'0" 3'6" x 7'0" | 2" x 4 1/2" | 40" x 120" 46" x 120" | 1" | | | | |

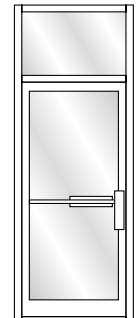

| Type | Part Number | Nominal Door Size | Non-thermal Framing | Frame Size | Glazing Pocket for | (-1) Clear | (-2) Dk. Bronze | (-4) White | (-5) Black |
|-------------|--|----------------------------|---------------------|----------------------------------|--------------------|------------|-----------------|------------|------------|
| CENTER HUNG | COC-ETDD-1- COC-ETDD-2- | 6'0" x 7'0" 7'0" x 7'0" | 1 3/4" x 4 1/2" | 75 1/2" x 120" 87 1/2" x 120" | 1/4" | | | | |
| | 1 COC-ETDD-1- 1 COC-ETDD-2- | 6'0" x 7'0" 7'0" x 7'0" | 2" x 4 1/2" | 76" x 120" 88" x 120" | 1" | | | | |
| OFFSET | CXC-ETDD-1- CXC-ETDD-2- | 6'0" x 7'0" 7'0" x 7'0" | 1 3/4" x 4 1/2" | 75 1/2" x 120" 87 1/2" x 120" | 1/4" | | | | |
| | 1 CXC-ETDD-1- 1 CXC-ETDD-2- | 6'0" x 7'0" 7'0" x 7'0" | 2" x 4 1/2" | 76" x 120" 88" x 120" | 1" | | | | |

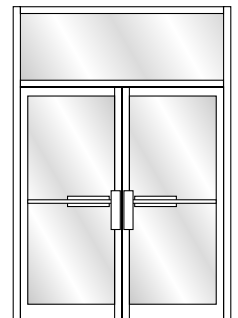

NOTE: Rebco Standard ADA Compliant Concealed Closer available

SHOWROOM ENTRANCE

(Not stocked)

STANDARD SHOWROOM UNIT INCLUDES:

Active Door

- 1 1/2 PR. Butts
- M.S. Lock with two cylinders
- Standard Push/Pull

Inactive Door

- 1 1/2 PR. Butts
- Flush Bolts
- Standard Push/Pull
- Narrow Stile Doors and 1 3/4" x 4 1/2" Framing
- Doors prepped for 1/4" glass
- 5" Aluminum Threshold
- No glass or closers are included.

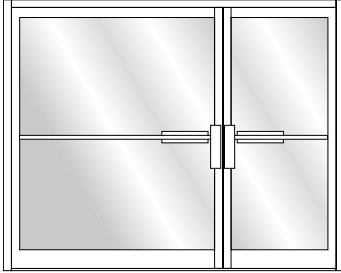

| Type | Part Number | Nominal Door Size | Non-thermal Framing | Frame Size | Glazing Pocket for | (-1) Clear | (-2) Dk. Bronze | (-4) White | (-5) Black |
|-------------------|-------------------|---------------------------------|---------------------|--------------------|--------------------|------------|-----------------|------------|------------|
| SHOWROOM ENTRANCE | S-EDD-1- | 3'0" x 7'0" & 5'0" X 7'0" | 1 3/4" x 4 1/2" | 99 1/2" x 85 3/4" | 1/4" | | | | |
| | S-EDD-2- | 3'6" x 7'0" & 5'0" X 7'0" | 1 3/4" x 4 1/2" | 105 1/2" x 85 3/4" | 1/4" | | | | |
| | 1 S-EDD-1- | 3'0" x 7'0" & 5'0" X 7'0" | 2" x 4 1/2" | 100" x 86" | 1" | | | | |
| | 1 S-EDD-2- | 3'6" x 7'0" & 5'0" X 7'0" | 2" x 4 1/2" | 106" x 86" | 1" | | | | |

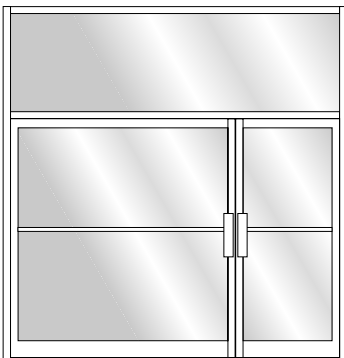

| Type | Part Number | Nominal Door Size | Non-thermal Framing | Frame Size | Glazing Pocket for | (-1) Clear | (-2) Dk. Bronze | (-4) White | (-5) Black |
|-------------------|--------------------|---------------------------------|---------------------|-----------------|--------------------|------------|-----------------|------------|------------|
| SHOWROOM ENTRANCE | S-ETDD-1- | 3'0" x 7'0" & 5'0" X 7'0" | 1 3/4" x 4 1/2" | 99 1/2" x 120" | 1/4" | | | | |
| | S-ETDD-2- | 3'6" x 7'0" & 5'0" X 7'0" | 1 3/4" x 4 1/2" | 105 1/2" x 120" | 1/4" | | | | |
| | 1 S-ETDD-1- | 3'0" x 7'0" & 5'0" X 7'0" | 2" x 4 1/2" | 100" x 120" | 1" | | | | |
| | 1 S-ETDD-2- | 3'6" x 7'0" & 5'0" X 7'0" | 2" x 4 1/2" | 106" x 120" | 1" | | | | |

BI-FOLD DOORS

Folding Doors (Narrow Stile) on Butt Hinges

STANDARD BI-FOLD UNITS INCLUDE

Active Leaf

- M.S. Lock with 2 cylinders
- Standard Push and Pull

Inactive Leaf

- Flush bolts
- Standard Push and Pull

Folding Leaves

- Surface Flush Bolts only (no Push or Pull)

Standard for all units

- Narrow Stile Door Only
- Doors to have 1-1/2 Pair Butts

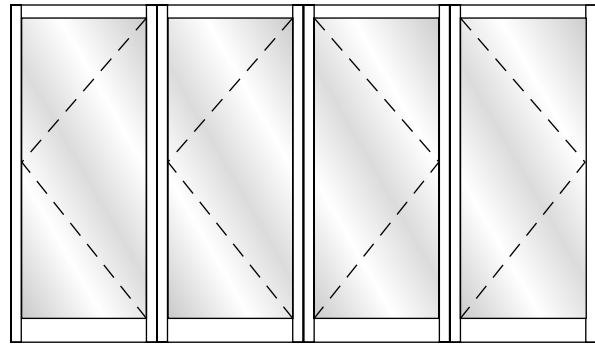

DOORS ONLY

| Part Number | Nominal Door Size | (-1) Clear | (-2) Dk. Bronze | (-4) White | (-5) Black |
|---------------|-------------------------------|---|-----------------|------------|------------|
| BFD-1 | 3070 DOORS (OR UNDERSIZED) | | | | |
| BFD-1X | OVERSIZED WIDTH OR HEIGHT | CONTACT OFFICE FOR PRICING AND AVAILABILITY | | | |

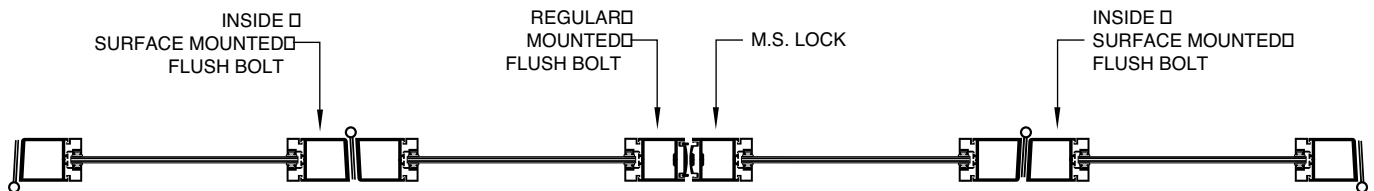

Note:

- The particular nature of Bifold Doors, most often, does not allow the doors to be of identical widths. Entrances will be calculated to provide as uniform a size as possible.
- To have doorstops in frames all doors must swing in or all doors must swing out.

REBCO BI-FOLD DOORS AND FRAMES

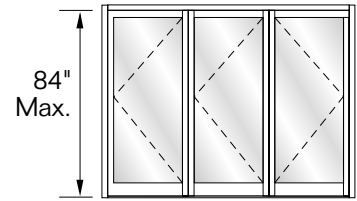

| Type | Part Number | Nominal Door Size | Framing | Max. Frame Size | (-1) Clear | (-2) Dk. Bronze | (-4) White | (-5) Black |
|---------|---------------|-------------------|---|---|------------|-----------------|------------|------------|
| BI FOLD | BFE-A1 | UP TO 3'0" x 7'0" | 1 ³ / ₄ " x 4 ¹ / ₂ " | UP TO 9'3 1/2" x 7'1 ³ / ₄ " | | | | |
| | BFE-A2 | UP TO 3'6" x 7'0" | 1 ³ / ₄ " x 4 ¹ / ₂ " | UP TO 10'9 1/2" x 7'1 ³ / ₄ " | | | | |

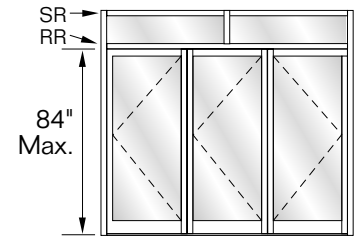

| Type | Part Number | Nominal Door Size | Framing | Max. Frame Size | Transom Pocket for | (-1) Clear | (-2) Dk. Bronze | (-4) White | (-5) Black |
|---------|---------------------------|-------------------|---|-------------------------|--------------------|------------|-----------------|------------|------------|
| BI FOLD | BFE-A1-T w/Transom | UP TO 3'0" x 7'0" | 1 ³ / ₄ " x 4 ¹ / ₂ " | UP TO 9'3 1/2" x 10'0" | 1/4" Glazing | | | | |
| | BFE-A2-T w/Transom | UP TO 3'6" x 7'0" | 1 ³ / ₄ " x 4 ¹ / ₂ " | UP TO 10'9 1/2" x 10'0" | 1/4" Glazing | | | | |

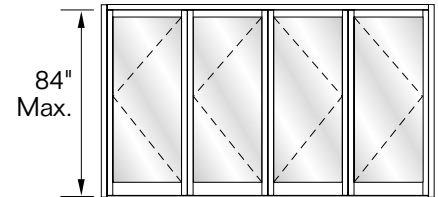

| Type | Part Number | Nominal Door Size | Framing | Max. Frame Size | (-1) Clear | (-2) Dk. Bronze | (-4) White | (-5) Black |
|---------|----------------|-------------------|---|---|------------|-----------------|------------|------------|
| BI FOLD | BFE-B1* | UP TO 3'0" x 7'0" | 1 ³ / ₄ " x 4 ¹ / ₂ " | UP TO 12'3 1/2" x 7'1 ³ / ₄ " | | | | |
| | BFE-B2 | UP TO 3'6" x 7'0" | 1 ³ / ₄ " x 4 ¹ / ₂ " | UP TO 14'3 1/2" x 7'1 ³ / ₄ " | | | | |

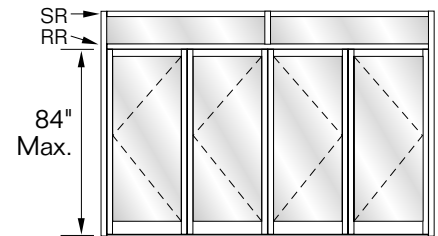

| Type | Part Number | Nominal Door Size | Framing | Max. Frame Size | Transom Pocket for | (-1) Clear | (-2) Dk. Bronze | (-4) White | (-5) Black |
|---------|----------------------------|-------------------|---|-------------------------|--------------------|------------|-----------------|------------|------------|
| BI FOLD | BFE-B1-T* w/Transom | UP TO 3'0" x 7'0" | 1 ³ / ₄ " x 4 ¹ / ₂ " | UP TO 12'3 1/2" x 10'0" | 1/4" Glazing | | | | |
| | BFE-B2-T w/Transom | UP TO 3'6" x 7'0" | 1 ³ / ₄ " x 4 ¹ / ₂ " | UP TO 14'3 1/2" x 10'0" | 1/4" Glazing | | | | |

***Option:** shown at right are options for units BFE-B1 and BFE-B1-T. These options are for use with doors up to 3'0" only.

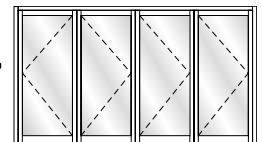

REBCO BI-FOLD DOORS AND FRAMES

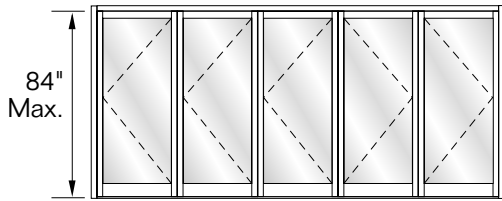

| Type | Part Number | Nominal Door Size | Non-thermal Framing | Max. Frame Size | (-1) Clear | (-2) Dk. Bronze | (-4) White | (-5) Black |
|---------|---------------|-------------------|---|--|------------|-----------------|------------|------------|
| BI FOLD | BFE-C1 | UP TO 3'0" x 7'0" | 1 ³ / ₄ " x 4 ¹ / ₂ " | UP TO 15'3 ¹ / ₂ " x 7'1 ³ / ₄ " | | | | |

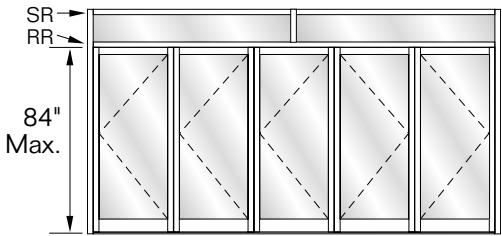

| Type | Part Number | Nominal Door Size | Non-thermal Framing | Max. Frame Size | Transom Pocket for | (-1) Clear | (-2) Dk. Bronze | (-4) White | (-5) Black |
|---------|---------------------------|-------------------|---|--|--------------------|------------|-----------------|------------|------------|
| BI FOLD | BFE-C1-T w/Transom | UP TO 3'0" x 7'0" | 1 ³ / ₄ " x 4 ¹ / ₂ " | UP TO 15'3 ¹ / ₂ " x 10'0" | 1/4" Glazing | | | | |

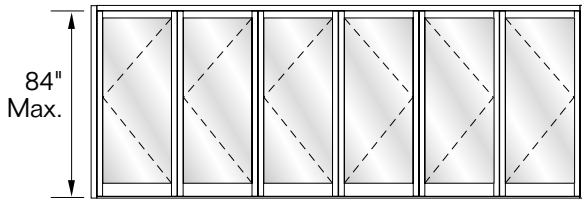

| Type | Part Number | Door Size | Framing | Frame Size | (-1) Clear | (-2) Dk. Bronze | (-4) White | (-5) Black |
|---------|---------------|-------------------|---|--|------------|-----------------|------------|------------|
| BI FOLD | BFE-D1 | UP TO 3'0" x 7'0" | 1 ³ / ₄ " x 4 ¹ / ₂ " | UP TO 18'3 ¹ / ₂ " x 7'1 ³ / ₄ " | | | | |

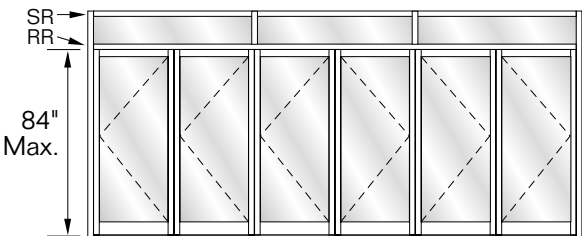

| Type | Part Number | Door Size | Framing | Max. Frame Size | Transom Pocket for | (-1) Clear | (-2) Dk. Bronze | (-4) White | (-5) Black |
|---------|---------------------------|-------------------|---|--|--------------------|------------|-----------------|------------|------------|
| BI FOLD | BFE-D1-T w/Transom | UP TO 3'0" x 7'0" | 1 ³ / ₄ " x 4 ¹ / ₂ " | UP TO 18'3 ¹ / ₂ " x 10'0" | 1/4" Glazing | | | | |

NOTE:

- BIFOLD UNITS ARE NOT TO BE USED WITH 1" GLASS OR WITH SIDELITES.
- MAXIMUM OF 3 DOORS HUNG FROM ONE JAMB.
- NO OUTSIDE POCKETS PROVIDED.

NARROW STILE

Entrance Doors

The best narrow stile door on the market!

With a wall thickness of .125" and stop thickness of .050", our doors are constructed with more metal than any other narrow stile door. (±.125" main members and .050 stop thickness)

Joints are mechanically fastened with the special REBCO fastener, then welded with a 100% deep penetration weld. To maintain the aesthetic beauty of our entrances, all welds are on unexposed surfaces. Complete with RebcO's standard push/pull, Adams-Rite Deadlock with cylinder both sides or flush bolts in the inactive leaf of pair. Threshold and closer not included.

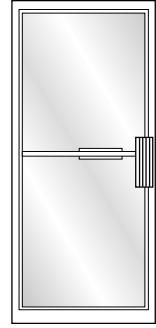

NOTE: Unless otherwise specified, doors prepped for 1/4" glass

| PART # | NARROW STILE DOORS | Size | (-1) Clear | (-2) Dk.Brnz. | (-4) White | (-5) Black |
|------------------------------|---|--------------------------------------|------------|---------------|------------|------------|
| NSB-1- NSB-2- | Butts (One Pair 4 1/2" x 4" B.B.) | Door 3'0" x 7'0" Door 3'6" x 7'0" | | | | |
| 2 NSB-1- 2 NSB-2- | Butts (One Pair 4 1/2" x 4" B.B. per door) | Pair 6'0" x 7'0" Pair 7'0" x 7'0" | | | | |
| NSP-1- NSP-2- | Offset Pivots (Top and Bottom) | Door 3'0" x 7'0" Door 3'6" x 7'0" | | | | |
| 2 NSP-1- 2 NSP-2- | Offset Pivots (Top and Bottom) One set per door | Pair 6'0" x 7'0" Pair 7'0" x 7'0" | | | | |
| NSN-1- NSN-2- | No Butts, No Pivots, No Butt or Pivot Preps | Door 3'0" x 7'0" Door 3'6" x 7'0" | | | | |
| 2 NSN-1- 2 NSN-2- | No Butts, No Pivots, No Butt or Pivot Preps | Pair 6'0" x 7'0" Pair 7'0" x 7'0" | | | | |
| NSO-1- NSO-2- | No Butts, No Pivots, No Lock, No Push/Pull | Door 3'0" x 7'0" Door 3'6" x 7'0" | | | | |
| 2 NSO-1- 2 NSO-2- | No Butts, No Pivots, No Lock, No Push/Pull | Pair 6'0" x 7'0" Pair 7'0" x 7'0" | | | | |
| | | | | | | |
| | | | | | | |
| | | | | | | |

| | PART # | CUSTOM PREPS | (-1) Clear | (-2) Dk.Brnz. | (-4) White | (-5) Black |
|--------------------|------------------------------|--|------------|---------------|------------|------------|
| CENTER HUNG | NSC-POC- NSC-PFC- | Prep only for C.O.C. or Floor Closer Cut top and bottom inside and outside web only | | | | |
| | NSC-ITA- NSC-IBA- | Install Customers Top or Bottom arm for closer Install customers top or bottom closer arm and top or bottom door portion of pivot. | | | | |
| | NSC-RAP- | Install REBCO's standard top arm and bottom door portion of pivot only | | | | |
| OFFSET | NSO-POC- NSO-PFC- | Prep only for C.O.C. or Floor Closer Cut top and/or bottom inside web as required and notch face of door for arm. | | | | |
| | NSO-ITA- NSO-IBA- | Install Customers top or bottom closer arm only Cut top and/or bottom inside web as required and notch face of door. Install closer arm. | | | | |
| | NSC-ROP- | Install REBCO's offset top arm & slide channel in door | | | | |

| D. O. | Actual Size | Part # | Glass Size | Clear Glass | Note: Glass width for C.H. Double Acting Doors, deduct 3/16" from glass sizes shown at left |
|-------------|-------------------|-----------------|---------------------|-------------|---|
| 2'6" x 7'0" | 29 7/8" x 83 1/4" | N/A | 25 3/8" x 76 11/16" | | |
| 3'0" x 7'0" | 35 7/8" x 83 1/4" | GLI (installed) | 31 3/8" x 76 11/16" | | |
| 3'0" x 7'0" | 35 7/8" x 83 1/4" | GLI-L (loose) | 31 3/8" x 76 11/16" | | |
| 3'6" x 7'0" | 41 7/8" x 83 1/4" | N/A | 37 3/8" x 76 11/16" | | |

| Part | Finish | Part # | Door Only | Part # | Door & Frame |
|---------------------------|--------|--------------|-----------|--------------|--------------|
| Extra Butt | Clear | 3BD-1 | | 3BF-1 | |
| | Bronze | 3BD-2 | | 3BF-2 | |
| Intermediate Pivot | Clear | IPD-1 | | IPF-1 | |
| | Bronze | IPD-2 | | IPF-2 | |

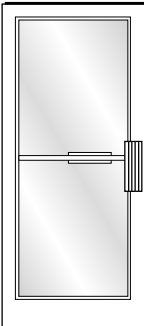

With a wall thickness of .125" and stop thickness of .050", our doors are constructed for superior durability. For strength, joints are mechanically fastened, interlocked, bolted and then welded with a 100% deep penetration weld. To maintain the aesthetic beauty of our entrances, all welds are on unexposed surfaces.

REBCO strongly recommends 3 butts or adding an intermediate pivot on medium stile doors.

3 1/2" MEDIUM STILE Entrance Doors

UNIT INCLUDES:

- Includes Pivots and Butts
- Threshold & Closer not included
- Deadlock with cylinder both sides or flush bolts in the inactive leaf of pair.
- Standard Push/Pull hardware

| PART # | MEDIUM STILE DOORS | Size | (-1) Clear | (-2) Dk.Brnz. | (-4) White | (-5) Black |
|-------------------------------------|---|--------------------------------------|------------|---------------|------------|------------|
| MSB-1-MSB-2- | Butts (One Pair 4 1/2" x 4" B.B.) | Door 3'0" x 7'0" Door 3'6" x 7'0" | | | | |
| 2 MSB-1-2 MSB-2- | Butts (One Pair 4 1/2" x 4" B.B. per door) | Pair 6'0" x 7'0" Pair 7'0" x 7'0" | | | | |
| MSP-1-MSP-2- | Offset Pivots (Top and Bottom) | Door 3'0" x 7'0" Door 3'6" x 7'0" | | | | |
| 2 MSP-1-2 MSP-2- | Offset Pivots (Top and Bottom) One set per door | Pair 6'0" x 7'0" Pair 7'0" x 7'0" | | | | |
| MSN-1-MSN-2- | No Butts, No Pivots, No Butt or Pivot Preps | Door 3'0" x 7'0" Door 3'6" x 7'0" | | | | |
| 2 MSN-1-2 MSN-2- | No Butts, No Pivots, No Butt or Pivot Preps | Pair 6'0" x 7'0" Pair 7'0" x 7'0" | | | | |
| MSO-1-MSO-2- | No Butts, No Pivots, No Lock, No Push/Pull | Door 3'0" x 7'0" Door 3'6" x 7'0" | | | | |
| 2 MSO-1-2 MSO-2- | No Butts, No Pivots, No Lock, No Push/Pull | Pair 6'0" x 7'0" Pair 7'0" x 7'0" | | | | |
| Add for Custom Size Up to 48" x 96" | | | | | | |
| Add for Custom Size Under 36" x 84" | | | | | | |

| | PART # | CUSTOM PREPS | (-1) Clear | (-2) Dk.Brnz. | (-4) White | (-5) Black |
|--------------------|-------------------------|--|-----------------------------------|---------------|------------|------------|
| CENTER HUNG | MSC-POC-MSB-PFC- | Prep only for C.O.C. or Floor Closer Cut top and bottom inside and outside web only | Includes Center Hung Door | | | |
| | MSC-ITA-MSB-IBA- | Install Customers Top or Bottom arm for closer Install customers top or bottom closer arm and top or bottom door portion of pivot. | | | | |
| | MSC-RAP- | Install REBCO's standard top arm and bottom door portion of pivot only | | | | |
| OFFSET | MSO-POC-MSO-PFC- | Prep only for C.O.C. or Floor Closer Cut top and/or bottom inside web as required and notch face of door for arm. | Add to butt or pivot door. | | | |
| | MSO-ITA-MSO-IBA- | Install Customers top or bottom closer arm only Cut top and/or bottom inside web as required and notch face of door. Install closer arm. | | | | |
| | MSC-ROP- | Install REBCO's offset top arm & slide channel in door | | | | |

| D. O. | Actual Size | Part # | Glass Size | Clear Glass | Note: Glass width for C.H. Double Acting Doors, deduct 3/16" from glass sizes shown at left |
|-------------|-------------------|------------|--------------------|-------------|---|
| 2'6" x 7'0" | 29 7/8" x 83 1/4" | N/A | 22 7/16" x 72 5/8" | N/A | |
| 3'0" x 7'0" | 35 7/8" x 83 1/4" | N/A | 28 7/16" x 72 5/8" | N/A | |
| 3'6" x 7'0" | 41 7/8" x 83 1/4" | N/A | 34 7/16" x 72 5/8" | N/A | |

| Part | Finish | Part # | Door Only | Part # | Door & Frame |
|---------------------------|--------|--------------|-----------|--------------|--------------|
| Extra Butt | Clear | 3BD-1 | | 3BF-1 | |
| | Bronze | 3BD-2 | | 3BF-2 | |
| Intermediate Pivot | Clear | IPD-1 | | IPF-1 | |
| | Bronze | IPD-2 | | IPF-2 | |

5" WIDE STILE

Entrance Doors

With a wall thickness of .125" and stop thickness of .050", our doors are constructed for superior durability. For strength, joints are mechanically fastened, interlocked, bolted and then welded with a 100% deep penetration weld. To maintain the aesthetic beauty of our entrances, all welds are on unexposed surfaces.

UNIT INCLUDES:

- Deadlock with cylinder both sides or flush bolts in the inactive leaf of pair.
- Standard Push/Pull hardware
- Includes Pivots and Butts
- Threshold & Closer not included

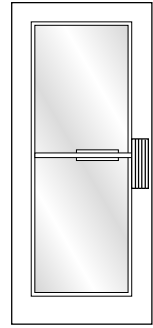

REBCO strongly recommends 3 butts or adding an intermediate pivot on wide stile doors.

| PART # | WIDE STILE DOORS | Size | (-1) Clear | (-2) Dk.Brnz. | (-4) White | (-5) Black |
|-------------------------------------|---|--------------------------------------|------------|---------------|------------|------------|
| WSB-1- WSB-2- | Butts (One Pair 4 1/2" x 4" B.B.) | Door 3'0" x 7'0" Door 3'6" x 7'0" | | | | |
| 2 WSB-1- 2 WSB-2- | Butts (One Pair 4 1/2" x 4" B.B. per door) | Pair 6'0" x 7'0" Pair 7'0" x 7'0" | | | | |
| WSP-1- WSP-2- | Offset Pivots (Top and Bottom) | Door 3'0" x 7'0" Door 3'6" x 7'0" | | | | |
| 2 WSP-1- 2 WSP-2- | Offset Pivots (Top and Bottom) One set per door | Pair 6'0" x 7'0" Pair 7'0" x 7'0" | | | | |
| WSN-1- WSN-2- | No Butts, No Pivots, No Butt or Pivot Preps | Door 3'0" x 7'0" Door 3'6" x 7'0" | | | | |
| 2 WSN-1- 2 WSN-2- | No Butts, No Pivots, No Butt or Pivot Preps | Pair 6'0" x 7'0" Pair 7'0" x 7'0" | | | | |
| WSO-1- WSO-2- | No Butts, No Pivots, No Lock, No Push/Pull | Door 3'0" x 7'0" Door 3'6" x 7'0" | | | | |
| 2 WSO-1- 2 WSO-2- | No Butts, No Pivots, No Lock, No Push/Pull | Pair 6'0" x 7'0" Pair 7'0" x 7'0" | | | | |
| Add for Custom Size Up to 48" x 96" | | | | | | |
| Add for Custom Size Under 36" x 84" | | | | | | |

| | PART # | CUSTOM PREPS | (-1) Clear | (-2) Dk.Brnz. | (-4) White | (-5) Black |
|-------------|----------------------|--|------------|---------------|------------|------------|
| CENTER HUNG | WSC-POC- WSC-PFC- | Prep only for C.O.C. or Floor Closer Cut top and bottom inside and outside web only | | | | |
| | WSC-ITA- WSC-IBA- | Install Customers Top or Bottom arm for closer Install customers top or bottom closer arm and top or bottom door portion of pivot. | | | | |
| | WSC-RAP- | Install REBCO's standard top arm and bottom door portion of pivot only | | | | |
| OFFSET | WSO-POC- WSO-PFC- | Prep only for C.O.C. or Floor Closer Cut top and/or bottom inside web as required and notch face of door for arm. | | | | |
| | WSO-ITA- WSO-IBA- | Install Customers top or bottom closer arm only Cut top and/or bottom inside web as required and notch face of door. Install closer arm. | | | | |
| | WSC-ROP- | Install REBCO's offset top arm & slide channel in door | | | | |

| D. O. | Actual Size | Part # | Glass Size | Clear Glass | Note: Glass width for C.H. Double Acting Doors, deduct 3/16" from glass sizes shown at left |
|-------------|-------------------|--------|--------------------|-------------|---|
| 2'6" x 7'0" | 29 7/8" x 83 1/4" | N/A | 19 3/8" x 71 1/16" | N/A | |
| 3'0" x 7'0" | 35 7/8" x 83 1/4" | N/A | 25 3/8" x 71 1/16" | N/A | |
| 3'6" x 7'0" | 41 7/8" x 83 1/4" | N/A | 31 3/8" x 71 1/16" | N/A | |

| Part | Finish | Part # | Door Only | Part # | Door & Frame |
|--------------------|--------|--------|-----------|--------|--------------|
| Extra Butt | Clear | 3BD-1 | | 3BF-1 | |
| | Bronze | 3BD-2 | | 3BF-2 | |
| Intermediate Pivot | Clear | IPD-1 | | IPF-1 | |
| | Bronze | IPD-2 | | IPF-2 | |

UNIT INCLUDES:

- M.S. lock with 2 cylinders or flush bolts in inactive leaf of pair.
- Standard Push/Pull hardware.
- Standard frames are 1³/₄" x 4¹/₂" with 5" threshold.
- Doors require 1¹/₂ pair butts or top, bottom & int. pivots.
- No center hung, C.O.C., or floor closer application possible.
- Concealed rod panics cannot be applied to full flush door.
- Rim panics or surface mounted vertical rod panic only.

FLUSH DOORS

Flush doors have welded frame construction with aluminum sheet laminations to 3/8" hardboard and honeycomb core. Vertical and horizontal reinforcing rails are installed inside the door skeleton for strength.

Flush doors are available with vision panels in standard or custom designs. **Facing can be either stucco .040 sheet or smooth surface – please specify.** Standard stucco finish will be used if no facing is specified.



| Type | Part Number | DOOR ONLY Size | | (-1) Clear | (-2) Dk. Bronze | (-4) White | (-5) Black |
|--------------|---------------|----------------|---|------------|-----------------|------------|------------|
| BUITT HUNG | FLB-1- | 3'0" x 7'0" | X | | | | |
| | FLB-2- | 3'6" x 7'0" | | | | | |
| OFFSET PIVOT | FLP-1- | 3'0" x 7'0" | | | | | |
| | FLP-2- | 3'6" x 7'0" | | | | | |

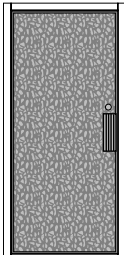

| Type | Part Number | Nominal Door Size | Non-thermal Framing | Frame Size | Glazing Pocket for | (-1) Clear | (-2) Dk. Bronze | (-4) White | (-5) Black |
|--------------|--------------------|-------------------|---|---|--------------------|------------|-----------------|------------|------------|
| BUITT HUNG | FLB-ED-1- | 3'0" x 7'0" | 1 ³ / ₄ " x 4 ¹ / ₂ " | 39 ¹ / ₂ " x 85 ³ / ₄ " | 1/4" | | | | |
| | FLB-ED-2- | 3'6" x 7'0" | | | | | | | |
| | 1 FLB-ED-1- | 3'0" x 7'0" | 2" x 4 ¹ / ₂ " | 40" x 86" | 1" | | | | |
| | 1 FLB-ED-2- | 3'6" x 7'0" | | | | | | | |
| OFFSET PIVOT | FLP-ED-1- | 3'0" x 7'0" | 1 ³ / ₄ " x 4 ¹ / ₂ " | 39 ¹ / ₂ " x 85 ³ / ₄ " | 1/4" | | | | |
| | FLP-ED-2- | 3'6" x 7'0" | | | | | | | |
| | 1 FLP-ED-1- | 3'0" x 7'0" | 2" x 4 ¹ / ₂ " | 40" x 86" | 1" | | | | |
| | 1 FLP-ED-2- | 3'6" x 7'0" | | | | | | | |

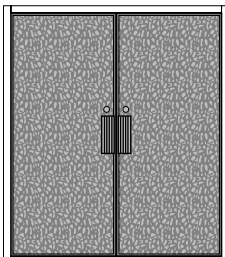

| Type | Part Number | Nominal Door Size | Non-thermal Framing | Frame Size | Glazing Pocket for | (-1) Clear | (-2) Dk. Bronze | (-4) White | (-5) Black |
|--------------|---------------------|-------------------|---|---|--------------------|------------|-----------------|------------|------------|
| BUITT HUNG | FLB-EDD-1- | 6'0" x 7'0" | 1 ³ / ₄ " x 4 ¹ / ₂ " | 75 ¹ / ₂ " x 85 ³ / ₄ " | 1/4" | | | | |
| | FLB-EDD-2- | 7'0" x 7'0" | | | | | | | |
| | 1 FLB-EDD-1- | 6'0" x 7'0" | 2" x 4 ¹ / ₂ " | 76" x 86" | 1" | | | | |
| | 1 FLB-EDD-2- | 7'0" x 7'0" | | | | | | | |
| OFFSET PIVOT | FLP-EDD-1- | 6'0" x 7'0" | 1 ³ / ₄ " x 4 ¹ / ₂ " | 75 ¹ / ₂ " x 85 ³ / ₄ " | 1/4" | | | | |
| | FLP-EDD-2- | 7'0" x 7'0" | | | | | | | |
| | 1 FLP-EDD-1- | 6'0" x 7'0" | 2" x 4 ¹ / ₂ " | 76" x 86" | 1" | | | | |
| | 1 FLP-EDD-2- | 7'0" x 7'0" | | | | | | | |

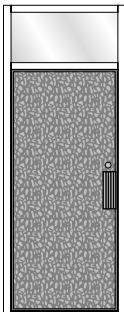

| Type | Part Number | Nominal Door Size | Non-thermal Framing | Frame Size | Glazing Pocket for | (-1) Clear | (-2) Dk. Bronze | (-4) White | (-5) Black |
|--------------|---------------------|-------------------|---|---|--------------------|------------|-----------------|------------|------------|
| BUITT HUNG | FLB-ETD-1- | 3'0" x 7'0" | 1 ³ / ₄ " x 4 ¹ / ₂ " | 39 ¹ / ₂ " x 120" | 1/4" | | | | |
| | FLB-ETD-2- | 3'6" x 7'0" | | | | | | | |
| | 1 FLB-ETD-1- | 3'0" x 7'0" | 2" x 4 ¹ / ₂ " | 40" x 120" | 1" | | | | |
| | 1 FLB-ETD-2- | 3'6" x 7'0" | | | | | | | |
| OFFSET PIVOT | FLP-ETD-1- | 3'0" x 7'0" | 1 ³ / ₄ " x 4 ¹ / ₂ " | 39 ¹ / ₂ " x 120" | 1/4" | | | | |
| | FLP-ETD-2- | 3'6" x 7'0" | | | | | | | |
| | 1 FLP-ETD-1- | 3'0" x 7'0" | 2" x 4 ¹ / ₂ " | 40" x 120" | 1" | | | | |
| | 1 FLP-ETD-2- | 3'6" x 7'0" | | | | | | | |

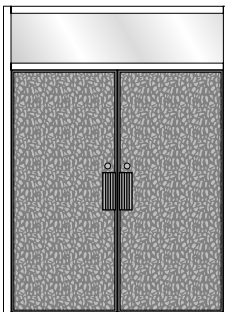

| Type | Part Number | Nominal Door Size | Non-thermal Framing | Frame Size | Glazing Pocket for | (-1) Clear | (-2) Dk. Bronze | (-4) White | (-5) Black |
|--------------|----------------------|-------------------|---|---|--------------------|------------|-----------------|------------|------------|
| BUITT HUNG | FLB-ETDD-1- | 6'0" x 7'0" | 1 ³ / ₄ " x 4 ¹ / ₂ " | 75 ¹ / ₂ " x 120" | 1/4" | | | | |
| | FLB-ETDD-2- | 7'0" x 7'0" | | | | | | | |
| | 1 FLB-ETDD-1- | 6'0" x 7'0" | 2" x 4 ¹ / ₂ " | 76" x 120" | 1" | | | | |
| | 1 FLB-ETDD-2- | 7'0" x 7'0" | | | | | | | |
| OFFSET PIVOT | FLP-ETDD-1- | 6'0" x 7'0" | 1 ³ / ₄ " x 4 ¹ / ₂ " | 75 ¹ / ₂ " x 120" | 1/4" | | | | |
| | FLP-ETDD-2- | 7'0" x 7'0" | | | | | | | |
| | 1 FLP-ETDD-1- | 6'0" x 7'0" | 2" x 4 ¹ / ₂ " | 76" x 120" | 1" | | | | |
| | 1 FLP-ETDD-2- | 7'0" x 7'0" | | | | | | | |

| Custom Sizing | Size | (-1) Clear | (-2) Dk. Brz. | (-4) White | (-5) Black |
|----------------------|-----------------------------|------------|---------------|------------|------------|
| ADD for special size | From 42" x 84" to 48" x 96" | | | | |

FRP DOORS

UNIT INCLUDES:

- Continuous Hinges.
- Bronze and clear finishes standard. Other colors available.
- High Density Polystyrene Core.
- Four member, heavy walled subframe with mortise and tenon joints.
- Fiberglass reinforced polyester panels are .120" thick.
- Color is solid throughout panels, making it scratch resistant.

- Aluminum Trim Caps.
- Single Pile weather-stripping for pairs of doors.
- Basic package consists of blank door panels. Push/pulls & locks are not included. See page 15 for hardware details.
- Top & Bottom Rails are 1 1/2" x 6"
- Side Rails are 1 1/2" x 5 3/4"
- Face sheets have a pebble-like embossed finish.

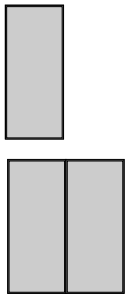

| Part Number | DOOR ONLY Nominal Size Door up to: |
|---------------|---------------------------------------|
| FRP-37 | 3'0" x 7'0" |
| FRP-38 | 3'0" x 8'0" |
| FRP-47 | 4'0" x 7'0" |
| FRP-48 | 4'0" x 8'0" |
| FRP-67 | 6'0" x 7'0" |
| FRP-68 | 6'0" x 8'0" |
| FRP-87 | 8'0" x 7'0" |
| FRP-88 | 8'0" x 8'0" |

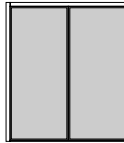

| Part Number | Nom. Door Size, up to: | Non-thermal Framing | Frame Size | Glazing Pocket for |
|---------------------|------------------------|---------------------|-------------------|--------------------|
| FRP-ED-37 | 3'0" x 7'0" | 1 3/4" x 4 1/2" | 39 1/2" x 85 3/4" | 1/4" |
| 1 FRP-ED-37 | 3'0" x 7'0" | 2" x 4 1/2" | 40" x 86" | 1" |
| FRP-ED-38 | 3'0" x 8'0" | 1 3/4" x 4 1/2" | 39 1/2" x 97 3/4" | 1/4" |
| 1 FRP-ED-38 | 3'0" x 8'0" | 2" x 4 1/2" | 40" x 98" | 1" |
| FRP-ED-47 | 4'0" x 7'0" | 1 3/4" x 4 1/2" | 51 1/2" x 85 3/4" | 1/4" |
| 1 FRP-ED-47 | 4'0" x 7'0" | 2" x 4 1/2" | 52" x 86" | 1" |
| FRP-ED-48 | 4'0" x 8'0" | 1 3/4" x 4 1/2" | 51 1/2" x 97 3/4" | 1/4" |
| 1 FRP-ED-48 | 4'0" x 8'0" | 2" x 4 1/2" | 52" x 98" | 1" |
| FRP-EDD-37 | 3'0" x 7'0" | 1 3/4" x 4 1/2" | 75 1/2" x 85 3/4" | 1/4" |
| 1 FRP-EDD-37 | 3'0" x 7'0" | 2" x 4 1/2" | 76" x 86" | 1" |
| FRP-EDD-38 | 3'0" x 8'0" | 1 3/4" x 4 1/2" | 75 1/2" x 97 3/4" | 1/4" |
| 1 FRP-EDD-38 | 3'0" x 8'0" | 2" x 4 1/2" | 76" x 98" | 1" |
| FRP-EDD-47 | 4'0" x 7'0" | 1 3/4" x 4 1/2" | 99 1/2" x 85 3/4" | 1/4" |
| 1 FRP-EDD-47 | 4'0" x 7'0" | 2" x 4 1/2" | 100" x 86" | 1" |
| FRP-EDD-48 | 4'0" x 8'0" | 1 3/4" x 4 1/2" | 99 1/2" x 97 3/4" | 1/4" |
| 1 FRP-EDD-48 | 4'0" x 8'0" | 2" x 4 1/2" | 100" x 98" | 1" |



Call for pricing.

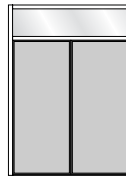

| Part Number | Nom. Door Size, up to: | Non-thermal Framing | Frame Size | Glazing Pocket for |
|---------------------|------------------------|---------------------|----------------|--------------------|
| FRP-ETD-37 | 3'0" x 7'0" | 1 3/4" x 4 1/2" | 39 1/2" x 120" | 1/4" |
| 1 FRP-ETD-37 | 3'0" x 7'0" | 2" x 4 1/2" | 40" x 120" | 1" |
| FRP-ETD-38 | 3'0" x 8'0" | 1 3/4" x 4 1/2" | 39 1/2" x 120" | 1/4" |
| 1 FRP-ETD-38 | 3'0" x 8'0" | 2" x 4 1/2" | 40" x 120" | 1" |
| FRP-ETD-47 | 4'0" x 7'0" | 1 3/4" x 4 1/2" | 51 1/2" x 120" | 1/4" |
| 1 FRP-ETD-47 | 4'0" x 7'0" | 2" x 4 1/2" | 52" x 120" | 1" |
| FRP-ETD-48 | 4'0" x 8'0" | 1 3/4" x 4 1/2" | 51 1/2" x 120" | 1/4" |
| 1 FRP-ETD-48 | 4'0" x 8'0" | 2" x 4 1/2" | 52" x 120" | 1" |

| Part Number | Nom. Door Size, up to: | Non-thermal Framing | Frame Size | Glazing Pocket for |
|----------------------|------------------------|---------------------|----------------|--------------------|
| FRP-ETDD-67 | 6'0" x 7'0" | 1 3/4" x 4 1/2" | 75 1/2" x 120" | 1/4" |
| 1 FRP-ETDD-67 | 6'0" x 7'0" | 2" x 4 1/2" | 76" x 120" | 1" |
| FRP-ETDD-68 | 6'0" x 8'0" | 1 3/4" x 4 1/2" | 75 1/2" x 120" | 1/4" |
| 1 FRP-ETDD-68 | 6'0" x 8'0" | 2" x 4 1/2" | 76" x 120" | 1" |
| FRP-ETDD-87 | 8'0" x 7'0" | 1 3/4" x 4 1/2" | 99 1/2" x 120" | 1/4" |
| 1 FRP-ETDD-87 | 8'0" x 7'0" | 2" x 4 1/2" | 100" x 120" | 1" |
| FRP-ETDD-88 | 8'0" x 8'0" | 1 3/4" x 4 1/2" | 99 1/2" x 120" | 1/4" |
| 1 FRP-ETDD-88 | 8'0" x 8'0" | 2" x 4 1/2" | 100" x 120" | 1" |

OPTIONS & ACCESSORIES

| | (-1) Clear /Gray | (-2) Bronze /Brown | Other Finishes |
|--|------------------|--------------------|----------------|
| Half Lite Top half of door only | | | |
| 10" x 10" or 12" x 12" Vision Lite Top of door only | | | |

| | (-1) Clear /Gray | (-2) Bronze /Brown | Other Finishes |
|---|------------------|--------------------|----------------|
| 5" x 30" Narrow Lite at top of door only | | | |
| Recessed Pull | | | |
| Additional Panels: for transom & sidelights, loose panels are available. | | | |

CUSTOM HARDWARE -

PUSH/PULLS Add on for REBCO standard Push & Pulls. **See pg. 22. Recessed pulls, see above.**

LOCKS MS or Latch Locks as required. **See page 24 & 25.**

PANIC DEVICES Door-o-matic Rim, A/R Mortised (8400) or A/R Surface Mounted Rods (8200) Panic. **See page 20.**

OTHER CUSTOM HARDWARE APPLICATION **Call our Door Department.**

DOOR GRIDS

CALL FOR PRICING

GRID CONSTRUCTION

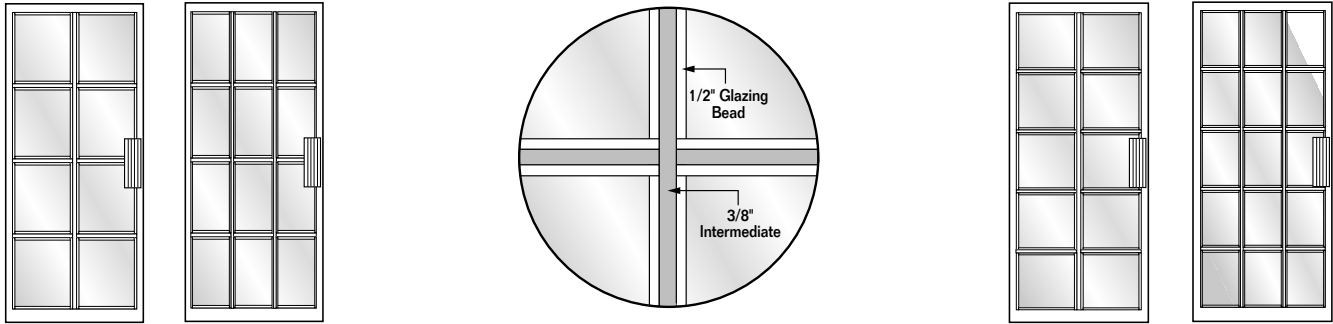

**Various Grid Configurations Available Upon Request.
Call for Pricing.**

The basic door is medium stile with a cross buck panel on the bottom. This panel is a full 1 1/2" thick for strength and insulation. (Also available is a smooth or stucco finished 1 1/2" panel in lieu of cross buck panel.) The Colonial door features an authentic six or nine lite colonial look with a 3" intermediate rail (excluding glass bead).

Custom sizes are also available. For custom sizes, see Medium Stile Doors on page 11.

Stiles: 3 1/2" • Bottom Rail: 6 13/16" • Top Rail: 3 7/16"
Vertical and Horizontal glass dividers 3/8" (excluding glass bead).

COLONIAL DOORS

With 6 or 9 Lites

STANDARD COLONIAL DOOR INCLUDES:

- Maximum security lock with cylinder both sides.
- 1 1/2 pair butts or top, bottom and intermediate pivot.
- Standard push/pull.

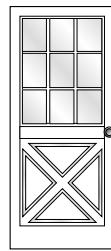
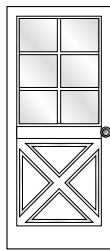
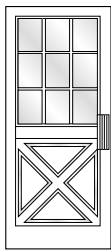
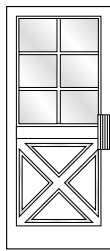

STANDARD PUSH/PULL

KNOB LOCK

DOORS ONLY

| Type | Nominal Door Size | 6 Lite Door Part Number | 6 Lite (-4) White Only | 9 Lite Door Part Number | 9 Lite (-4) White Only |
|--------------|-------------------|-------------------------|------------------------|-------------------------|------------------------|
| BUTT HUNG | 3'0" x 7'0" | CL-BD6-1 | | CL-BD9-1 | |
| | 3'6" x 7'0" | CL-BD6-2 | | CL-BD9-2 | |
| OFFSET PIVOT | 3'0" x 7'0" | CL-PD6-1 | | CL-PD9-1 | |
| | 3'6" x 7'0" | CL-PD6-2 | | CL-PD9-2 | |

| KNOB LOCK OPTION | |
|------------------|-------------------|
| Knob lock set | See pg. 26 |
| Dummy Knob lock | See pg. 26 |

CUSTOM PANEL DOORS



| DOOR | PANEL | PART # | (-1) CLEAR | (-2) DK.BRNZ. | (-4) WHITE | (-5) BLACK |
|--|--------------------------|--------------|-------------------|-------------------|---------------|---------------|
| 1/4" Full Panel with Required 2" Intermediate Rail | Anodized 1/4" Panel | QFPA- | | | | |
| | Painted 1/4" Panel | QFPP- | (-9) Paint | (-3) Paint | | |
| Full Panel | Painted * 1" | OFPP- | (-9) Paint | (-3) Paint | | |
| | Anodized Rebco 1 1/2" | RFPA- | | | | |
| Horizontal Half Panel 41-5/8" to centerline of mid-rail from bottom of door (2" intermediate rail.) | 1/4" Anod. | QHHA- | | | | |
| | 1/4" Paint | QHHP- | | | | |
| | * 1" Paint | OHHP- | | | | |
| | 1 1/2" Anod. | RHHP- | | | | |
| Vertical Half Panel Includes 41030 Muntin | 1/4" Anod. | QVHA- | | | | |
| | 1/4" Paint | QVHP- | | | | |
| | *1" Paint | OVHP- | | | | |
| | 1 1/2" Anod. | RVHP- | | | | |
| Sign Panel (10-3/4") 45-3/8" from top of sign panel to bottom of door | 1/4" Anod. | QSPA- | | | | |
| | 1/4" Paint | QSPP- | | | | |
| | *1" Paint | OSPP- | | | | |
| | 1 1/2" Anod. | RSPA- | | | | |
| 12" x 12" or 24" x 24" Vision Panel | 1/4" Anod. | | | | | |
| | *1" Paint | | | | | |
| | 1 1/2" Anod. | SVP- | | | | |
| 6" x 36" Vision Panel | 1/4" Anod. | | | | | |
| | *1" Paint | | | | | |
| | 1 1/2" Anod. | RVP- | | | | |
| Any Other Size of Vision Panel | 1/4" Anod. | | | | | |
| | *1" Paint | | | | | |
| | 1 1/2" Anod. | CVP- | | | | |

NOTE: Standard anodized panels and standard painted panels are Stucco finish. Smooth anodized panels available at no extra charge but must be requested.

*1" Panel is available in painted finishes only (not anodized).

CUSTOM RAILS & KICKPLATES

INTERMEDIATE HORIZONTAL RAIL

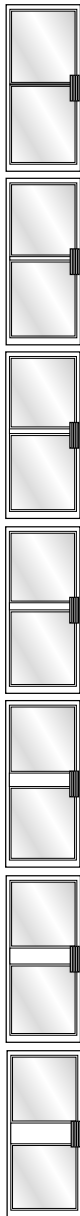

| | | |
|---|--|--|
| 3/8" (H41-020) Intermediate Rail (Size does not include Glass Beads) | (-1) Clear (-2) Dk.Brz. (-4) White (-5) Black | |
| 2" (H41-030) Intermediate Rail (Size does not include Glass Beads) | (-1) Clear (-2) Dk.Brz. (-4) White (-5) Black | |
| 3" (H41-035) Intermediate Rail (Size does not include Glass Beads) | (-1) Clear (-2) Dk.Brz. (-4) White (-5) Black | |
| 4-1/2" (H41-045) Intermediate Rail (Size does not include Glass Beads) | (-1) Clear (-2) Dk.Brz. (-4) White (-5) Black | |
| 5-3/4" (H41-057) Intermediate Rail (Size does not include Glass Beads) | (-1) Clear (-2) Dk.Brz. (-4) White (-5) Black | |
| 7-9/16" (H41-067) Intermediate Rail (Size does not include Glass Beads) | (-1) Clear (-2) Dk.Brz. (-4) White (-5) Black | |
| 10" (H41-010) Intermediate Rail (Size does not include Glass Beads) | (-1) Clear (-2) Dk.Brz. (-4) White (-5) Black | |

| | | |
|---|--|--|
| <p>DECO-MIDPANEL Complete with M.S. Lock, 2 cylinders and tapered push/pull. Panel area supplied open with glazing beads to insert 1/4" panel or glass. (White door gets clear accessories).</p> | | |
| Deco-Midpanel add on for doors up to 42" wide (D-MP) | (-1) Clear (-2) Dk.Brz. (-4) White (-5) Black | |
| For special size over 42" x 84" up to 48" x 96" (D-MPX) | (-1) Clear (-2) Dk.Brz. (-4) White (-5) Black | |

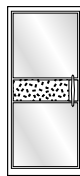

KICKPLATE (Applied to both sides of door)



| | | .080 | .125 |
|---|--|------|------|
| (KP12-) up to 12" high 1/8" Aluminum Kickplate | (-1) Clear (-2) Dk.Brz. (-4) White (-5) Black | | |
| (KP18-) up to 18" high 1/8" Aluminum Kickplate | (-1) Clear (-2) Dk.Brz. (-4) White (-5) Black | | |
| (KP24-) up to 24" high 1/8" Aluminum Kickplate | (-1) Clear (-2) Dk.Brz. (-4) White (-5) Black | | |
| (KP36-) up to 36" high 1/8" Aluminum Kickplate | (-1) Clear (-2) Dk.Brz. (-4) White (-5) Black | | |

VERTICAL RAILS

Glass and/or Panels not included. Unless a custom vertical rail location is requested, vertical rails will be mounted 1/3rd of the door width from the lock stile.

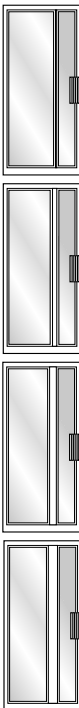

| | | |
|-----------------------------------|--|--|
| 3/8" (V41-020) Vertical Rail | (-1) Clear (-2) Dk.Brz. (-4) White (-5) Black | |
| 2" (V41-030) Vertical Rail | (-1) Clear (-2) Dk.Brz. (-4) White (-5) Black | |
| 3" (V41-035) Vertical Rail | (-1) Clear (-2) Dk.Brz. (-4) White (-5) Black | |
| 4-1/2" (V41-045) Vertical Rail | (-1) Clear (-2) Dk.Brz. (-4) White (-5) Black | |

DOOR GLAZING BEADS

Standard Doors will be prepped for 1/4" glazing unless otherwise specified.

Options at no charge: Door can be prepped for 5/8" or 1" glazing upon request only.

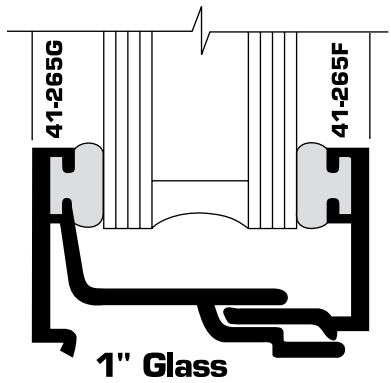
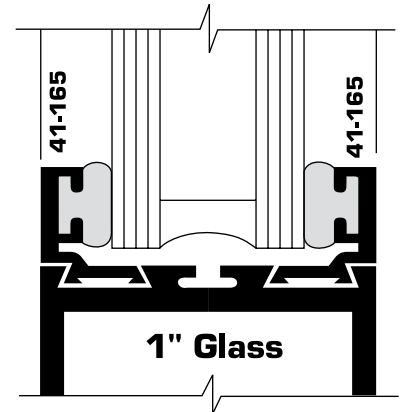
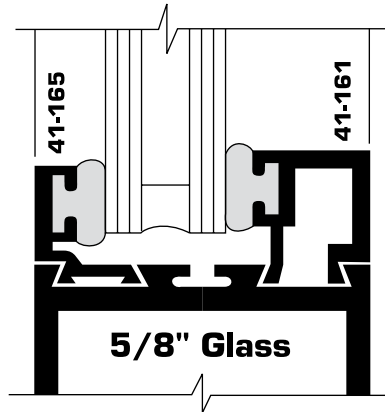
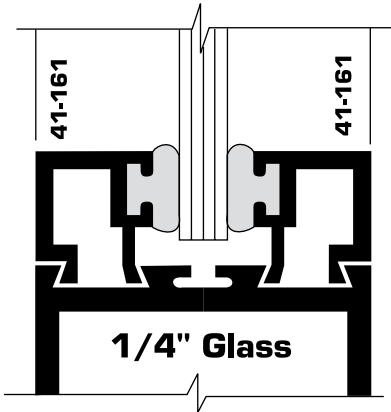

Special 1" Glazing - #41-265I

2 piece glazing member providing extra height for coverage of most spacers used in 1" thermal glass units.

| ADD TO BASIC DOOR | | | | | |
|-------------------|-----------------|------------|-------------|------------|------------|
| Part # | Components | Clear (-1) | Bronze (-2) | White (-4) | Black (-5) |
| 41-6161 | 41-161/41-161 | | | | |
| 41-6165 | 41-165/41-161 | | | | |
| 41-6565 | 41-165/41-165 | | | | |
| 41-265I | 41-265F/41-265G | | | | |

PREPARED ALUMINUM THRESHOLDS

| ITEM | BUTTS | | OFFSET PIVOTS PREP ONLY | | * FOR C.H. PIVOT PREP ONLY | |
|---|------------------|----------------|----------------------------|----------------|-------------------------------|----------------|
| | SINGLE to 42" | PAIR to 84" | SINGLE to 42" | PAIR to 84" | SINGLE to 42" | PAIR to 84" |
| 4" Threshold #62-040 | #62-041 | #62-042 | #62-043 | #62-044 | #62-045 | #62-046 |
| 5" Threshold #62-050 | #62-051 | #62-052 | #62-053 | #62-054 | #62-055 | #62-056 |
| 5" Panic Threshold #62-057 P-0 | #62-057PB-0 | #62-059PB-0 | #62-057PP-0 | #62-059PP-0 | | |
| 4 1/2" Panic Threshold (1/2" Overall Height) #62-058W | #62-058B | #62-059B | | | | |
| 6" Threshold #62-060 | #62-061 | #62-062 | #62-063 | #62-064 | #62-065 | #62-066 |
| 7" Threshold #62-070 | #62-071 | #62-072 | #62-073 | #62-074 | #62-075 | #62-076 |

* If pivots other than REBCO standards are being used, floor portion of pivot must be provided. 62-058 W cannot be used with Pivots. Special Thresholds are available upon request to meet your specifications.

HEADERS & CLOSERS (Concealed and Surface Mounted)

| PART # | HEADERS ONLY – Prepared for C.O.C. Closers Add closer. Add channel cover door stop if offset. | (-1) CLEAR | (-2) DK. BRONZE | (-4) WHITE | (-5) BLACK |
|-----------------|--|--------------------|--------------------|---------------|---------------|
| 64-45H1- | 4517 OH & OHF | Single Door to 42" | | | |
| 64-45H2- | w/cover plate | Pair to 84" | | | |
| 64-42H1- | 4017, 4517 or 4520 System | Single Door to 42" | | | |
| 64-42H2- | w/cover plate | Pair to 84" | | | |
| 64-68H1- | 6017, 6020 or 8020 System | Single Door to 42" | | | |
| 64-68H2- | w/cover plate | Pair to 84" | | | |

| LOOSE - C. O. C. OPTIONS | PART # | CENTERHUNG | | | | OFFSET | | | |
|---|-----------------|---------------|------------------|---------------|---------------|--|------------------|---------------|---------------|
| | | (-1) CLEAR | (-2) DK. BRZ. | (-4) WHITE | (-5) BLACK | (-1) CLEAR | (-2) DK. BRZ. | (-4) WHITE | (-5) BLACK |
| Concealed Overhead Closer Set: (Closer, End Load Arm & Brackets) Specify Hold Open, No Hold Open & Degree of Opening (90° or 105°) | 64-CCA | | | | | | | | |
| | 64-XCA | | | | | (Includes Offset Arm & Slide Channel) | | | |
| A.D.A. Compliant C.O.C. Set: (A.D.A Compliant Closer End Load Arm & Brackets) 105° Hold Open Stocked | 64-CCADA | | | | | | | | |
| | 64-XCADA | | | | | (Includes Offset Arm & Slide Channel) | | | |
| End Load Arm Only | 64-ARM | | | | | | | | |
| Offset Arm Only | 64-XAC | | | | | N/A | N/A | N/A | N/A |
| Offset Arm & Slide Channel-Sets only | 64-ASC | | | | | | | | |
| Cover Plate Only - International | 64-CPO | | | | | | | | |
| Channel Door Stop (for offset arm up to 42") | 64-XDS | | | | | | | | |

| INSTALLED - C.O.C. OPTIONS Includes closer mounted in header. If not specified, 105° hold open closer will be provided. | | PART # CENTER HUNG | CENTERHUNG | | | | PART # OFFSET | OFFSET (Includes loose channel door stop) | | | |
|--|--------------------|--------------------------|---------------|------------------|---------------|---------------|------------------|--|------------------|---------------|---------------|
| | | | (-1) CLEAR | (-2) DK. BRZ. | (-4) WHITE | (-5) BLACK | | (-1) CLEAR | (-2) DK. BRZ. | (-4) WHITE | (-5) BLACK |
| In 4517 OH Header | Single Door to 42" | 64-5CH1I- | | | | | 64-5XH1I- | | | | |
| | Pair to 84" | 64-5CH2I- | | | | | 64-5XH2I- | | | | |
| In 4017, 4517 or 4520 System | Single Door to 42" | 64-2CH1I- | | | | | 64-2XH1I- | | | | |
| | Pair to 84" | 64-2CH2I- | | | | | 64-2XH2I- | | | | |
| In 6020 or 8020 Systems | Single Door to 42" | 64-8CH1I- | | | | | 64-8XH1I- | | | | |
| | Pair to 84" | 64-8CH2I- | | | | | 64-8XH2I- | | | | |
| Other | | | | | | | | | | | |

| PART# | SURFACE CLOSERS | (-1) CLEAR | (-2) DK. BRONZE | (-4) WHITE | (-5) BLACK | W/H.O. STD. | W/H.O. BRONZE |
|------------------|--|--|--------------------|---------------|---------------|----------------|------------------|
| 64-CL1- | International Closer #784 each | | | | | | |
| 64-CLG- | International Closer, Case of 6 | | | | | | |
| 64-CLADA- | ADA Compliant International Closer (#8052) | | | | | | |
| 64-PAK- | Parallel Arm Kit - (with bracket) | | | | | | |
| 64-BC1- | 4 - B.C. | | | | | | |
| 64-DPL- | Drop Plate | | | | | | |
| | Special: LCN, Norton, Rixson Etc. | Price and Availability upon Request | | | | | |



SURFACE VERTICAL ROD PANIC

| PART NO. | INSTALLED HARDWARE | (-1) Clear | (-2) Dk.Brnz. |
|-----------------|---|------------|---------------|
| 64-SVRP- | Adams Rite #8200, 7' 0", Surface Mounted Vertical Rod Panic w/Offset Wire Pull & Cylinder | | |

RIM PANIC

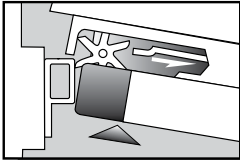

| PART NO. | INSTALLED HARDWARE | (-1) Clear | (-2) Dk.Brnz. |
|-----------------|--|------------|---------------|
| 64-ARRP- | Adams Rite #8800 7' 0", with Offset Wire Pull & Cylinder | | |

#8800

MORTISED PANIC

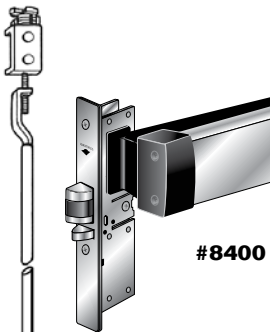

| PART NO. | INSTALLED HARDWARE | (-1) Clear | (-2) Dk.Brnz. |
|----------------|---|------------|---------------|
| 64-AMP- | Adams Rite #8400 Panic (MORTISED) with Offset Wire Pulls & Cylinder | | |
| 64-ADP- | Adams Rite #8099 Dummy Panic with Pull Provided. | | |

#8400

CONCEALED ROD PANIC



| PART NO. | INSTALLED HARDWARE | (-1) Clear | (-2) Dk.Brnz. |
|-----------------|--|------------|---------------|
| 64-ARCP- | Adams Rite #8600 7' 0", with Offset Wire Pull & Cylinder | | |

#8600

IN-LINE PANICS

INSTALLED ONLY, PANICS WITH INT. RAIL & OFFSET WIRE PULLS.

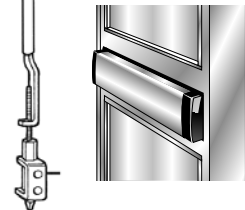

| PART NO. | INSTALLED | (-1) Clear | (-2) Dk.Brnz. |
|-----------------|---|------------|---------------|
| 64-8475- | 8475 – Mortised (for use in Narrow Stile Door Only) | | |
| 64-8675- | 8675 – Concealed Rod | | |

REMOVABLE MULLION

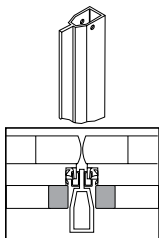

| PART NO. | INSTALLED Use with Medium or Wide Stile Door | (-1) Clear | (-2) Dk.Brnz. |
|----------------|--|------------|---------------|
| 64-RM7- | Removable Mullion to 7'0" installed by Rebco | | |
| 64-RM8- | Removable Mullion to 8'0" installed by Rebco | | |

PANIC OPTIONS



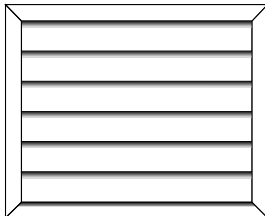

List

| | |
|------------------------------|--|
| Cylinder Dogging in Push Bar | |
| Lever Trim at Exterior | |



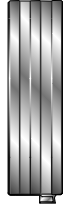

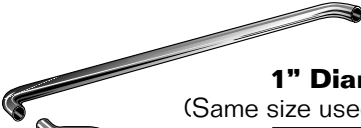
CUSTOM ADD-ONS

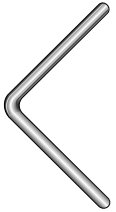
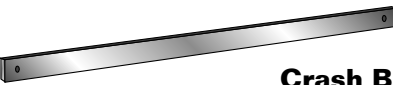
| PART # | DESCRIPTION | (-1) CLEAR | (-2) DK.BRNZ. | (-4) WHITE | (-5) BLACK |
|-------------------|---|---------------|------------------|---------------|---------------|
| .25DF-SMP | 1/4" Double Faced Anodized Panel Smooth Finish .040 sheet both sides. Minimum 2 sq. ft. | | | | |
| 150DF-SMP | 1-1/2" Double Faced Anodized Panel Smooth Finish .040 sheet both sides. Minimum 2 sq. ft. | | | | |
| .25DF-STP | 1/4" Double Faced Anodized Panel Stucco Finish .040 sheet both sides. Minimum 2 sq. ft. | | | | |
| 150DF-STP | 1-1/2" Double Faced Anodized Panel Stucco Finish .040 sheet both sides. Minimum 2 sq. ft. | | | | |
| | | | | | |
| | | | | | |
| 41-TRM | Top Door Rail Modification | | | | |
| 41-BRM | Bottom Door Rail Modification | | | | |
| 41-7BR | Add for Installation of 7" Bottom Rail on Narrow Stile Door In Door in Lieu of Regular Rail | | | | |
| 41-10BR-N | 10" Bottom Rail on Narrow Stile Door | | | | |
| 41-10BR-AO | 10" Bottom Rail on Medium or Wide Stile Door | | | | |
| | | | | | |
| | | | | | |
| | | | | | |
| 41 - LVRA | <p>Louver 1-1/2" louver in 1-3/4" wide channel frame. Fabricated & installed by REBCO in a REBCO door.</p>  | | | | |
| | | | | | |

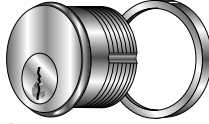

HANDLES CUSTOM HANDLES AVAILABLE UPON REQUEST

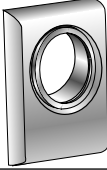
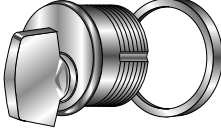
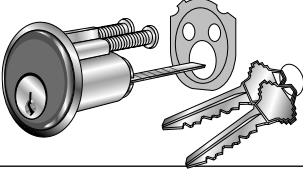
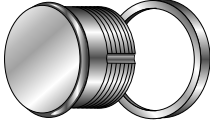
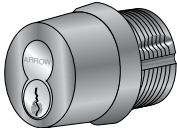
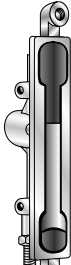
| PART # | DESCRIPTION | (-1) Clear | (-2) Dark Bronze | Special | Installed |
|--------|---|------------|------------------|---------------------------|-----------|
| 64-102 |  REBCO Push Bar Assembly | | | | |
| 64-103 |  REBCO Pull Handle 12" Long – 10 3/8" C/L | | | | |
| 64-106 |  Hallet Pulls per set Available Through Door or Glass Mounting – 8" C/L Handle 16" overall in length | | | | |
| 64-109 |  1" Diameter Wire Push (Same size used on NS, MS, WS doors) | | | | |
| 64-108 |  1" Diameter Wire Pull Handle 12" C/L | | | | |
| 64-189 | 1" Dia. Wire Push/Pull Assembly | | | | |
| 64-110 |  "V" Wire Pull Handle 12" C/L | | | Each Back To-Back Pair | |
| 64-126 |  Crash Bars (up to 42") | | | | |
| | | | | | |

CYLINDERS

| PART # | DESCRIPTION | (-1) Clear | (-2) Dark Bronze | Special | INST |
|--------|---|------------|------------------|---------|------|
| 64-321 |  <p>REBCO Solid Brass Mortise Cylinder</p> | | | | |
| 64-322 |  <p>15/16" Depth (Also used with A.R. 8400 & 8600 Panics)</p> | | | | |
| 64-ESC |  <p>Escutcheon Used on 8600 Panics</p> | | | | |
| 64-323 |  <p>Solid Brass Thumb Turn Cylinder 15/16" Depth</p> | | | | |
| 64-324 |  <p>Solid Brass Rim Cylinder 15/16" Depth Used with Dor-O-Matic Panics</p> | | | | |
| 64-325 |  <p>Dummy Cylinder 15/16" Depth</p> | | | | |
| 64-BWC |  <p>Arrow Mortise or Rim Cylinder with IC Core (Includes Construction Core)</p> | | | | |
| 64-330 |  <p>Complete Flush Bolt with Rod</p> | | | | |
| 64-331 |  <p>Cylinder Operated Flush Bolt with Cylinder</p> | | | | |
| 64-332 | <p>Installed Face Mounted Flush Bolts</p> | | | | |

LOCKS

| PART # | DESCRIPTION | (-1) Clear | (-2) Dark Bronze | Special | INST |
|--------|--|---------------|---------------------|---------|------|
| 64-301 |  <p>Adams Rite Maximum Security Lock 1-1/8" B.S.</p> | | | | |
| 64-302 | <p>With Face Plate. No Cylinders Included.</p> <p>1-1/2" B.S.</p> | | | | |
| 64-303 |  <p>M.S. + 1890 Hook Lock + Latch Lock 1-1/8" B.S.</p> | | | | |
| 64-304 | <p>With Face Plate & 1893 Strike. No Cylinder or Lever Handles Included. Locks are handed</p> <p>1-1/2" B.S.</p> | | | | |
| 64-307 |  <p>Adams Rite Short Throw Lock 1-1/8" B.S.</p> <p>Includes Face Plate. No Cylinders Included. Only 1-1/8" B.S. in stock.</p> <p>1-1/2" B.S.</p> | | | | |
| 64-SLL | Special Location of M/S or Latch Lock | | | | |
| 64-602 | Supply and Install Extra M/S Lock & 2 Cylinders – 1-1/8" B.S. | | | | |
| 64-604 | Supply and Install Extra M/S Lock & 2 Cylinders – 1-1/2" B.S. | | | | |
| 64-BRL | Supply and Install Deadbolt in Top or Bottom Rail | | | | |
| 64-2PL | Supply and Install 2 Point Dead Lock with Cylinder | | | | |
| 64-3PL | Supply and Install 3 Point Dead Lock with Cylinder | | | | |
| | | | | | |

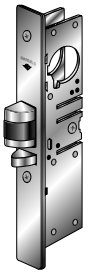
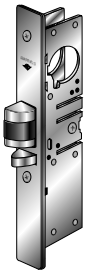
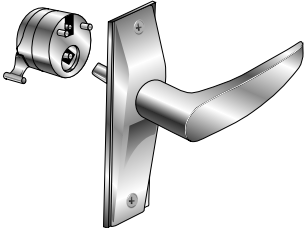
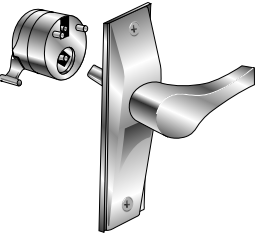
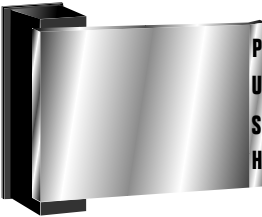
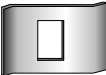
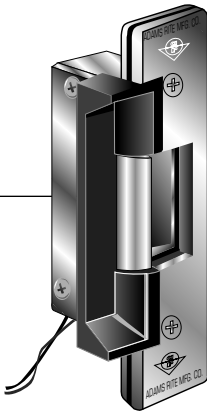

LOCK HANDLES CUSTOM HANDLES AVAILABLE UPON REQUEST

| PART # | DESCRIPTION | (-1) Clear | (-2) Dark Bronze | Special | INST |
|---------|---|---------------|---------------------|---------|------|
| 64-308 |  <p>Latch Lock (Handed) 1-1/8" B.S.</p> | | | | |
| 64-309 |  <p>With Face Plate No Cylinder No Levers or Paddles incl. 1-1/2" B.S.</p> | | | | |
| 64-310 |  <p>Lever Handle (with Cam) For Latch Lock</p> | | | | |
| 64-311 |  <p>Short Lever Handle (with Cam) For Latch Lock</p> | | | | |
| 64-312 |  <p>Push or Pull Paddle Swing of Door Needed</p> | | | | |
| 64-313 |  <p>Regular Latch Lock Strike</p> | | | | |
| 64-313R | <p>Retrofit Latch Lock Strike Used when replacing MS Lock with Latch Lock</p> | | | | |
| 64-314 |  <p>Adams Rite Electric Release Standard 24 Volts</p> | | | | |
| 64-315 | | | | | |
| 64-316 | | | | | |
| 64-317 | | | | | |

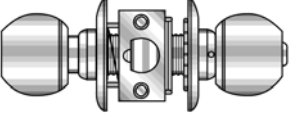
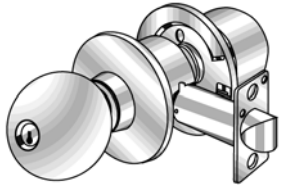



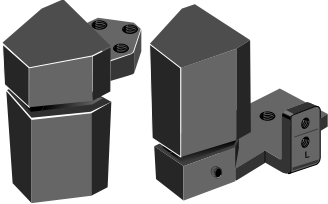
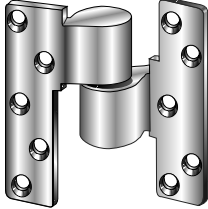
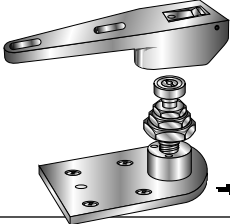
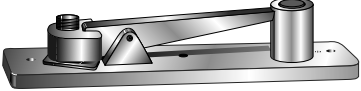

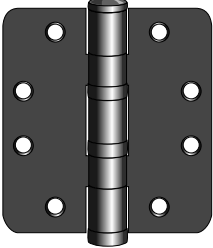
LATCH & LEVER LOCKS

| PART # | DESCRIPTION | (-1) Clear | (-2) Dark Bronze | Special | INST |
|----------|--|---|------------------|---------|------|
| 64-318 |  <p>Knob Lock No Key Way – Passage Set for MS or WS Doors Only</p> | | | | |
| 64-318-D | Dummy Knob Lock – for MS or WS Doors Only Knobs only - no latching mechanism included | | | | |
| 64-319 |  <p>Knob Lock with Key Way for MS or WS Doors Only</p> | | | | |
| 64-LLE | Supply & Install Latch Lock, Lever Cylinder & Electric Release (24V) | | | | |
| 64-LPE | Supply & Install Latch Lock, Paddle, Cylinder & Electric Release (24V) | | | | |
| 64-LLS | Supply & Install Latch Lock, Lever, Cylinder & Latch Lock Strike | | | | |
| 64-LPS | Supply & Install Latch, Paddle, Cylinder & Latch Lock Strike | | | | |
| | | | | | |
| 64-TSU | Deadbolt/Latch Combo (MS1890) Supply & Install – Latch Lock with 2 Levers, MS Lock, 2 cylinders and MS 1890 Strike | | | | |
| 64-AHS | Apt. House Set-up Offset Wire Pull – with Latch, Folger Adams Electric Release Lock, Cylinder and Short Vertical Lever - Installed | | | | |
| | | | | | |
| 41-050 | <p style="text-align: center;">For Pair of Doors</p> <p>REBCO Astragal (installed)</p> <p style="text-align: center;">For Single Door & Frame</p> | | | | |
| 41-051 | | | | | |
| 64-FAE | Folger Adams Electric Release (includes bridge rectifier for AC) | US10B finish available by special order only | | | |
| 64-FAA | Folger Adams Astragal | | | | |
| | | | | | |

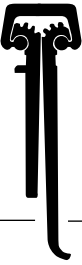
PIVOTS & BUTTS

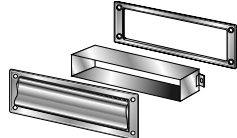
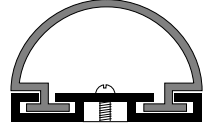
| PART # | DESCRIPTION | (-1) Clear | (-2) Dark Bronze | Special | INST |
|---------|--|------------|------------------|---------|------|
| 64-340 |  <p>REBCO Complete Set of Offset Pivots (Handed) Sold in Sets Only</p> | | | | |
| 64-341 |  <p>REBCO Intermediate Pivot Full Mortised – Handed</p> | | | | |
| 64-383D | Intermediate Pivot Back-up Plate - Door or Jamb | | | | |
| 64-383J | | | | | |
| 64-344 |  <p>Center Hung Bottom Pivot Set Door & Threshold Portion Used in lieu of threshold only.</p> | | | | |
| 64-346 |  <p>Center Hung Top Pivot – Frame Portion “Walking Beam”</p> | | | | |
| 64-345 |  <p>Center Hung Top Pivot – Door Portion Channel with Bushing</p> | | | | |
| 64-381 |  <p>4-1/2" x 4" B.B. Butts (Non-Ferrous) Standard (Non-Removable Pin)</p> | | | | |
| 64-SBL | Special Location – Pair of Butts | | | | |
| 64-DMB | Double Mortise Butts – Door Only – Per Pair | | | | |
| 64-382D | Butt Back-up Plate – Door or Jamb | | | | |
| 64-382J | | | | | |

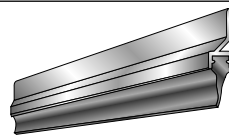
MISCELLANEOUS

| PART # | DESCRIPTION | (-1) Clear | (-2) Dark Bronze | Special | Installed |
|---|--|---------------|---------------------|---------|-----------|
| 64-384FM-1 64-384FMX-1 64-384FMXL-1 |  <p>Continuous Full Mortise Hinge Surface Mounted</p> <p>83" height 95" height 120" height Above 8'</p> | | | | |
| 64-384FS-1 64-384FSX-1 64-384FSXL-1 |  <p>Continuous Full Surface Hinge Surface Mounted</p> <p>83" height 95" height 120" height Above 8'</p> | | | | |
| | <p>Other Continuous Hinges Are Available Call for Price & Lead Time. Add 30% for H.D. Cont. Hinges</p> | | | | |
| 64-450 |  <p>Drop Arm Door Holder</p> | | | | |
| 64-460 |  <p>8-3/4" x 3" Mail Slot With Sleeve (7-1/4" x 2-1/4")</p> | | | | |
| 41-100 |  <p>Finger Guard 7'0" Long (for CH door only)</p> | | | | |
| 42-079 | <p>Crash Chains</p>  <p>20-1/2" for 30" Door 25-1/2" for 36" Door 27-1/2" for 42" Door</p> | | | | |
| 42-080 |  <p>Door Bottom Sweep 42" Long with screws</p> | | | | |
| 68-103 |  <p>Touch Up Spray Paint 16 oz.</p> <ul style="list-style-type: none"> • Clear (-1) • Bronze Anodized (-2) • Bronze Paint (-3) • White Paint (-4) • Black Anodized (-5) | | | | |
| | | | | | |

INSTALLATION OF HARDWARE SUPPLIED BY OTHERS

NOTE: Hardware and Templates must be supplied for prep and/or installation by REBCO.
We cannot work from templates alone. Customer must supply hardware.

| PART # | ITEM | | FABRICATE TO DOOR | FABRICATE TO FRAME |
|---------|--|---|-------------------|--------------------|
| 64-001 | Top or Bottom Offset Pivot | Rixson or Similar | | |
| 64-002 | Intermediate Pivot | M19 or Similar | | |
| 64-003 | Top Center Hung Pivot (Walking Beam) | | | |
| 64-004 | Bottom Center Hung Pivot | Narrow Stile Door Medium or Wide Stile Door | | |
| 64-005 | Butt Hinge Installation - Other than Stock Size | (4-1/2" x 4-1/2", 5" x 5", etc.) | | |
| 64-006 | Continuous Hinge (Marker, Roton, Pemko, Zero, Etc.) | Surface Mounted Mortised (incl. under sizing door) | | |
| 64-007 | Install COC Arm in Door | Center Hung | | |
| 64-008 | Install COC Arm in Door | Offset | | |
| 64-009 | Install COC in Header | | | |
| 64-0011 | Surface Overhead Holder | | | |
| 64-0012 | Concealed Overhead Holder | | | |
| 64-0013 | Install Header for Automatic Closer | | | |
| 64-0014 | Install Floor Closer Arm in Door | Center Hung | | |
| 64-0015 | Install Floor Closer Arm in Door | Offset | | |
| 64-0016 | Prepare 7" Threshold with cutouts for Floor Closer | up to 42" | | |
| 64-0017 | Prepare 7" Threshold with cutouts for Floor Closer | up to 84" | | |
| 64-0018 | Deadlock (M.S. Lock) – Similar to Adams Rite | | | |
| 64-0019 | Latchlock – Similar to Adams Rite | | | |
| 64-0020 | Locks which require Special Cutouts – Price determined upon review of lock | | | |
| 64-0021 | Knob Locks – Similar to Kwikset | | | |
| 64-0022 | Full Mortise Lockset – Corbin or similar | | | |
| 64-0023 | Dummy Knob Lock | | | |
| 64-0024 | Unicorn or Simplex Lock | | | |
| 64-0025 | Flush Bolts – Regular or Face Mounted | | | |
| 64-0026 | Cylinder Operated Flushbolts | | | |
| 64-0027 | Back to Back Thru Bolt Handles – Push/Pull Combo or Pair Pull | | | |
| 64-0028 | Kick Plate – Pre-drilled | | | |
| 64-0029 | Concealed Panic – no cylinder outside | | | |
| 64-0030 | Concealed Panic – with cylinder outside | | | |
| 64-0031 | Rim Panic – no cylinder outside | | | |
| 64-0032 | Rim Panic – with cylinder outside | | | |
| 64-0033 | Mortised Panic | | | |
| 64-0034 | Removable Mullion | | | |
| 64-0035 | Special Outside Trim for Panics | | | |